



CABLE & HOSE REELS



"The Wire to leave the maze" 

50
years

— 1969 - 2019 —

CUSTOMIZE YOUR EQUIPMENT

We know what is like to be the favourite opinion at the time of electrification of equipments for some of the most important end users all over the world, and we have years of experience innovating for the best alternative for our customers.

That is why, **AUXEMA-STEMMANN**, as a reference brand name in the electrical feeding of industrial mobile equipment in the past century, wants to introduce you to his full range of motorized cable reels.

Suitable for Ports, Shipyards, Mining Steel plants, Cement plants, and everywhere is required we will provide you the most appropriate choice at the time helping you to choose your cable reel. All the engineering and technical

development, as well as the manufacturing of the goods with first quality and friendly materials, is self-made by **AUXEMA-STEMMANN**. We are also proud of being one of the unique supplier which can deliver a fully tested cable reel, as well as installation and / or commissioning support at site could be provided.

Our efforts, reflected on our range of products, are focused on improving the efficiency of the mobile equipments to lead for the friendliest environment possible using cleaner sources of energy as electricity. **AUXEMA-STEMMANN**'s cable reels are specially designed for this purpose too, offering the greatest results in terms of durability, and prolonging your cables life thanks to its fine regulation.



CABLE REELS

ATTENTION!

In machines with a short travel distance and using an inexpensive cable, a cable control system is not generally worthwhile, since it is uneconomical to use reels which cost much more than the cable. For installations where the cable has a significant value (more than 150 m of cable approximately, but always depending of the cross section), end user must decide if it is worthwhile or not to control and regulate the cable tension.

Besides from the high costs of the cable itself, the benefit of a machine is measured by its hours of operation and, its operation must be assured. The problem is more noticeable when dealing with 6, 10, 15, 20 or 33 kV cables, as their cross section is usually small and, they offer no advantages as far as mechanical work is concerned. In this case, control and regulation of cable tension are essential.

In this fields of activity **AUXEMA-STEMMANN** supplies motorized, manual, counterweight and spring-operated

units. We can supply from the smallest reels (weight around 4 – 5 kg) to the largest (1000 – 1500 m of cable), at voltages up to 30 KV according to the requirements on the international market and for translation or elevation speeds up to 300 m.p.m. This is carried out thanks to our special testing point, where we test our products under real operating speeds, accelerations and conditions (ATEX 21, ATEX 22 and IECex).

On motor-driven cable reels for energizing mobile machines, the problem of synchronizing machine speed and cable winding/unwinding speed is usually solved as follows:

- AS-DRIVE. Short-circuit rotor 3- phase induction motors
- Asynchronous motor drive by frequency converters INDARFREC
- Magnetic clutches INDARMAGNETIK
- Other types like, Wound rotor 3- phase induction motors, mechanical friction clutches INDARMIK, hydraulic clutches INDARHYDRAULIK or electromagnetic clutches INDAR-EMAGNETIK.



AS – DRIVE®

AUXEMA-STEMMANN is pleased to present our AS-DRIVE system, second generation torque motors, own developed system which consists in a motor with a trapezoid shape torque curve, special for long travelling distances (even for more than 1000 m travelling length).

It can be blocked or stalled at very low currents, or which can be made to rotate against the –field of rotation without excessive overheating.

It is, of course, especially made for this purpose, offering better results than other drives like clutches for similar use (see figure).



Hydrodynamic	Magnetic coupling system	AS-DRIVE®
Needs periodical adjusting of the friction clutch	Needs periodical adjusting for a longer life of the system	Does not need any adjusting after the start work
Cable deterioration by extra-stress	Cable deterioration by extra-stress	Cable deterioration only by ageing
Because of the ageing the base actionning system has to be changed	Usually the clutches have to be changed because they loose magnetism	No changes needed by ageing
Auxiliary systems for lifting the cable are needed when travelling long distances (cable on "S" suffering in excess)	Working with long travelling distances needs many motors and clutches which complicates the maintenance	Does not need auxiliary systems for long travelling distances
It is not possible to regulate: reeling, unreeling and halfway pieces (factor daimeter)	It is not possible to regulate: reeling, unreeling and halfway pieces (factor diameter)	Regulation is possible, and it is easy to do.

AS – DRIVE®



MAIN APPLICATIONS

In every field where a cable reel is needed such as ports, shipyards, cement plants, steel mills, tunnelling machines, mining, theatres, ...

- Short and long distances for mobile machines, for even more than 1200 m. of travelling length.
- Low and medium speeds up to 80m/min.
- Every kind of work cycles: of 100% ED

There are not problems regarding wear or torque variation due to the ambient temperature (cooled by fan or natural) and the cable pull can be adjusted even during operation by changing the power supply voltage.

Used during decades by AUXEMA-STEMMANN, this system is well-known because of its good performing and long lasting combined with an amazing simple system at the best price.

No one ever get such an amazing regulation without the necessity of a frequency converter.

AUXEMA STEMMANN, can also provide it under ATEX22, ATEX21 and IECEX standards.

Advantages of using AS-DRIVE®

No mechanic or electric attrition

It does not use electronics (less complication)

It offers the possibility to regulate discriminating reeling/unreeling and intermediate pieces of the length

Not deterioration by means of rough changes of voltage

Free of electric and electronic maintenance

Simple start on, without resistor modifies

Cables last longer due to the regulation

INDARFREC[®] DRIVE

INDARFREC is an electronic system for the traction regulation on cable reels. This system offers many advantages like the longer durability of the cable due to the minimum traction force suffered by the cable. All this is obtained by means of a simple control cabinet in which the number of electronic compounds has been reduced to the minimum.

AUXEMA-STEMMANN accumulates many experiences of equipment working successfully with the most well-known frequency converter manufacturers; having the knowledge for all of them and also offering the possibility to the end user of installing the one of their choice.

The frequency converter must know permanently the position of the cable reel. This information is given by the limit switches and potentiometers located in the cable guide and near the drum. As much information receives a better control will get. It consist on:

The cabinet obtains this way a great simplicity and a protection of IP65 minimum.

The motor is controlled permanently by the frequency converter, this converter gives to the motor the current, the voltage and the frequency it needs at every single moment.



- A frequency converter (Trade mark could be chosen by the customer)
- Some contactors to activate the different parts of the system.
- Emergency lights and potentiometers for adjusting.
- PLC or any other kind of electronic logic.

This system does not need any manipulation after a very simple start on.



INDARFREC[®] DRIVE

MAIN APPLICATIONS

All the field previously mentioned (ports, mining, steel plants, shipyards,...) with the possibility of manufacturing special equipment for translation or elevation.

· Short, medium and long distances, reaching the longest ones (more than 1500 m).

· All possible work cycles; 100% ED.

· Incredible speeds up to 300 m.p.m. with the next regulation.

· Specially recommended for one of today's hot topic; Electrification of RTG.



INDARMAGNETIK[®] DRIVE

This drives are operated and used similarly to the previous, with the advantage that they do not suffer any wear.

INDARMAGNETI[®] DRIVE are used on small reels, therefore several clutches driving a single crown-wheel have been used making it possible to adjust the torque on the shaft of the reel while operating.

It also uses several motors (4 or 5) in a drive of 5 or 6 kW.

This set-up has the disadvantage of having to mount several pinions to drive a single crown wheel, making it impossible to spread the load eventually.



WOUND ROTOR INDUCTION & TORQUE MOTORS

It can be used on all sizes and capacities of cable reels whose winding speed is less than 120 m.p.m. Beyond that speed, it may not be fully satisfactory.

By combining rotor resistance with thyristors, the field of adjustment can be greatly extended, making the motor work in four quadrants, braking or transmitting energy according to the signal received from the cable tensions control.

These work in the same way as the squirrel cage motors. They are used in the same way as electromagnetic clutches, and cable pull can be modified by adjusting rotor resistance during operation.

They can be used on reels of all sizes, and for all winding speeds. It work almost as satisfactory as D/C motor systems.



WOUND MOTOR	AS DRIVE®	INDARFREC®
APPLICATION		
Cable reels for translations & lifting, with heavy-duty dynamic requirements, e.g.: - Continuous operation 100% ED or 60% ED. - Cable reels with large cross-sections cables, long travels & erection heights of 6 m. - High speeds up to 120 m/min.	Translation cable reels with medium-duty dynamic requirements, e.g.: - Duty cycle 100% - Cable reels with large cross-section cables and erection heights of 6 m & 20 m.	Same requirements as the wound rotor torque motor, but with greater capacity for continuous use up to speeds of 300 m/min and for installations that require extremely fine adjustment.

ADVANTAGES

Main advantages of these 3 drive systems over other drive systems for cable reels are:

- No readjustment required throughout the lifetime of the cable reel
- Adjusting possibility, so cables deterioration comes only through ageing and UV radiation, not through stress
 - No drive changes required due to ageing and/or wear
 - No auxiliary start-up systems required for long lengths, e.g.
- Pull & Store or more than one motor and clutch on the same gearbox.
 - Can be adjusted

<ul style="list-style-type: none"> - Robust - Easy to operate, as commercially available electromechanical parts are used. Control cabinet easy to set up with supervision from AUXEMA- STEMMANN	<ul style="list-style-type: none"> - Robust - Easy to operate, as commercially available electromechanical parts are used. - Control cabinet easy to set up with supervision from AUXEMA- STEMMANN <ul style="list-style-type: none"> - No rotor resistor element required for operation. - Easy to start up, with easily change adjustment. - No electrical maintenance required. 	<ul style="list-style-type: none"> - Extremely fine adjustment. - Possibility of high performance. - Up to 50% less bulky, lighter drives. - Short delivery times
--	---	---

DISADVANTAGES

<ul style="list-style-type: none"> - Adjustment during start-up may be difficult. - Rotor brushes require maintenance. - Bulky drives. Needs rotor heating element to operate (bulky accessory)	<ul style="list-style-type: none"> - Lightly more bulky 	<ul style="list-style-type: none"> - Cabinet with elements less accessible to installation and/or maintenance personnel: this must be done by AUXEMA- STEMMANN. Must be started up by highly qualified staff from AUXEMA- STEMMANN .
--	--	---

COMPARARISON OF THE 3 DRIVE SYSTEMS

	WOUND MOTOR	AS DRIVE®	INDARFREC®
Dymanic performance	★ ★ ★	★ ★	★ ★ ★ ★
Start-up	★ ★	★ ★ ★ ★	★
Possibilit of adjustment	★ ★	★ ★	★ ★ ★ ★
Robustness	★ ★ ★ ★	★ ★ ★ ★	★ ★ ★
After sales service	★ ★	★ ★	★ ★ ★
Maintenance	★ ★	★ ★ ★ ★	★ ★ ★
Prices for traslation 60% ED meium	★ ★ ★	★ ★ ★ ★	★
Prices for translation	★ ★ ★	★ ★ ★ ★	★
Price for 100% ED high performance & lifting	★ ★	★ ★ ★	★ ★ ★ ★

SLIPRING ASSEMBLIES AND ROTARY JOINS FOR FIBRE OPTIC AND FLUIDS

These revolving systems are used as electrical link between the rotating and the fix part. More than two systems may be involved, but only at low speed. Rings are usually made of copper or brass, depending of the application (diameter, power to be transmitted, etc).

It can be supplied for any capacity and application. As this might sound exaggerated please do not hesitate to send us your inquiry. We have built them for up to 30.000 volts. Is possible supply rotary joints for fluids as per example, water, oil, air, any gas, etc.

Insulation should be at least in accordance with the standards. Our sliprings has flexible brush - holders which adapt themselves to the diameter of the ring. Brush-holders has stainless steel springs.

We supply special equipment for signal transmission, with gold-plated and silvered plated rings, also we can supply electrodes submerged in mercury for signal transmission through optical fibres or equipment with present frequencies between transmitter and receiver.

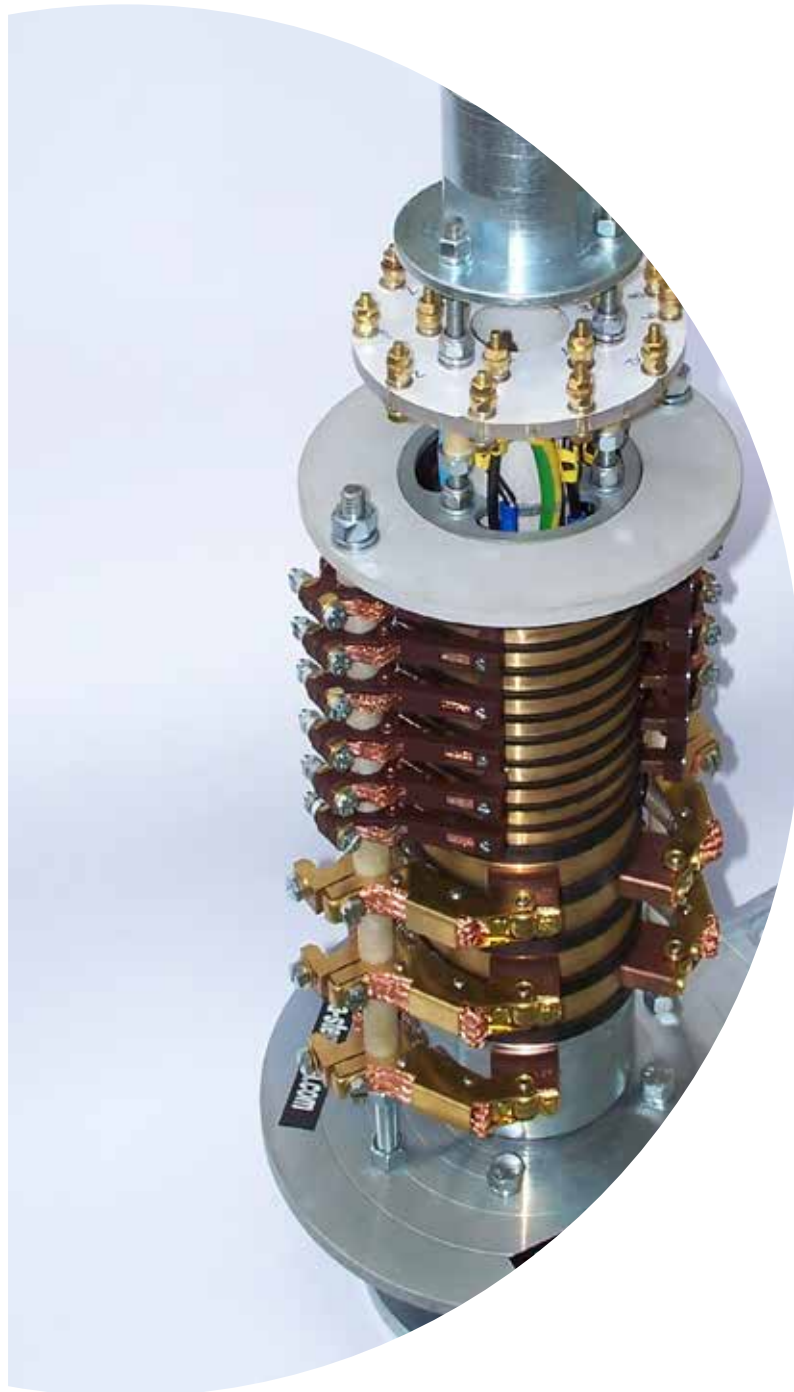

CABLE GUIDES

This accessory is fundamental because it drives the cable onto the floor, and also the cable guide control the traction of the cable when the machines is working.

Special device to be incorporated as an option, for the rubber cover channel protection (Recommended AUXEMA-STEMMANN system BELTFLEX, see pag.14). Different AUXEMA STEMMANN designs depending on the chosen cable; with pendulum and limit switch (AUXEMA-STEMMANN in house made) for control tight and slack cable and reeling direction.



LIMIT SWITCHES, POTENTIOMETERS AND CABLES

Switch limit of strong construction in aluminium alloy. Axle in oxidable steel mounted on bearings free of maintenance.

Limit switch specially designed for work in positions, distance limitations both in translations and elevations. The cams are metallic and easily adjustable.

The contacts may be of sudden or slow rupture and in 1NA and 1NC execution.

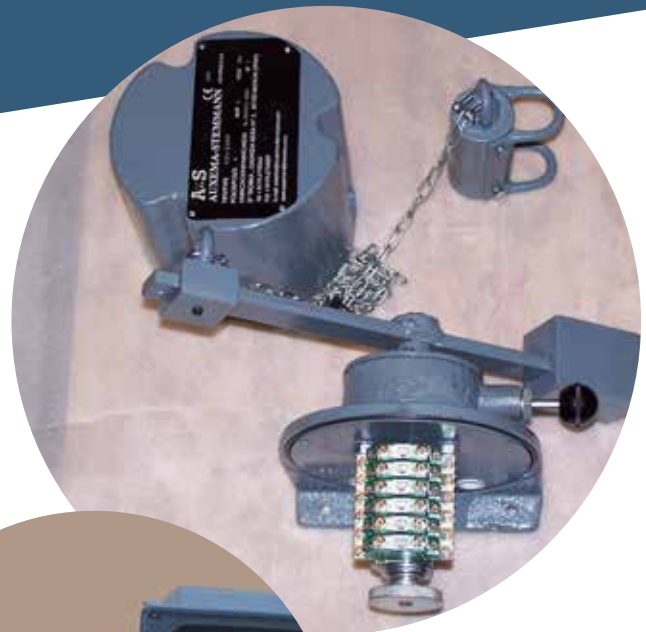

BELTFLEX[®] CABLE TRENCH

	BELTFLEX	BELTFLEX X	BELTFLEX SX	BELTFLEX SXP
Description	Designed for Sea-Side. Very light traffic and pedestrian crossing.	Designed for occasional traffic and pedestrian crossing.	Designed for usual light traffic and occasional heavy traffic.	Designed for very intensive heavy traffic.
Thickness	≥ 15 mm	≥ 15 mm	≥ 15 mm	≥ 15 mm
Composition	80% CR Neopren 15% Steel cord 5% Dipped Nylon	75% CR Neopren 20% Steel cord 5% Dipped Nylon	72% CR Neopren 23% Steel cord 5% Dipped Nylon	50% CR Neopren 40% Steel cord 10% Dipped Nylon
Temperatura Range	-35°C up to +120°C -31°F up to 248°F	-35°C up to +120°C -31°F up to 248°F	-35°C up to +120°C -31°F up to 248°F	-35°C up to +120°C -31°F up to 248°F
Transversal Breaking Load	≥ 250 N/mm	≥ 500 N/mm	≥ 790 N/mm	≥ 790 N/mm
Longitudinal Breaking Load	≥ 100 N/mm	≥ 100 N/mm	≥ 500 N/mm	≥ 700 N/mm

Composition–Neoprene rubber specific formula for marine environments 65° SHORE

Opening Angle	90	Degrees
Estimated Runtime	> 1.500.000	cycles
Hardness	62 ± 5	°Sh A
Abrasion	130	mm3
Breaking Elongation	400	%



Company:	Tel:
Contact person:	Fax:
Date:	E-mail:

- Type of machine to be energized (STS, RTG, Gantry crane, travelling crane, jib crane...)
- Possible layouts. Reel on machine and cable supported. Reel on machine with cable freely tightened. Reel fixed with cable pull from machine, cable pull parallel to reel shaft, cable pull perpendicular to reel shaft
- Electric power to be taken into consideration in continuous service or a description of the receivers and their work cycle voltage system
- Total travel length of the machine
- Feeding point or location of the power outlet with respect to the machine travel (at one end, centre...)
- Travel speed of the machine
- Mounting height from the ground or the cable support surface to the reel mounting platform
- Work cycle of the movement deal with
- If the customer already has the cable, outside diameter, weight per metre and the minimum curvature diameter admitted by the supplier
- Type of drive: AS DRIVE motor Motor with converter Spring drive Wound rotor motor INDARMAGNETIC INDARDINAMIC Counter weight

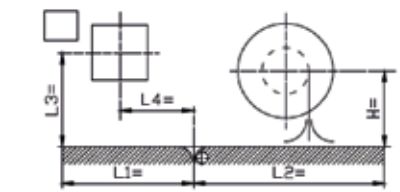

Fig. 1 - Horizontal cable pull in one both directions.

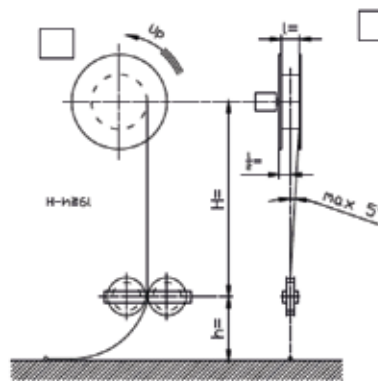

Fig. 2 - Roller guide layout.

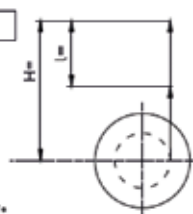

Fig. 3 - Vertical upward cable pull.

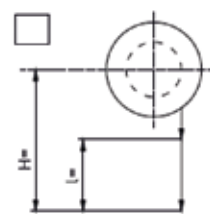

Fig. 4 - Vertical downward cable pull.

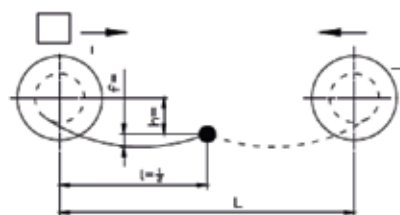

Fig. 5 - Winding with free tightening of cable. Mobile reel.

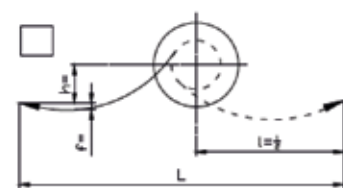

Fig. 6 - Winding with free tightening of cable. Fixed reel.

- Slipping assembly: Standrd ATEX Special design
- Desired exterior steel surface treatment
- Special motor protections (e.g. thermostat)
- Cable guide: yes no. Rollers: yes no. Rollers curve: yes no.
- Anchorage system: yes no.

Other comments:

All our range product can be manufactured under UL/ CSA/ NEMA/ ATEX/ IECEx standards under request





Auxema Stemmann S.L
Gazanda 3, 48100 Mungua-Vizcaya (Spain)
Tel. +34-946740362/ Fax.+34-946744859
E-mail:auxema@auxema-stemmann.com
www.auxema-stemmann.cin

"The Wire to leave the maze" 