



Industrias GALARZA, S.A.®

Leaders in electrical conductivity since 1958

CATALOGUE 2020



TRACK PROFILE

**MAX. LOAD
PER TROLLEY**

DESCRIPTION

SERIES

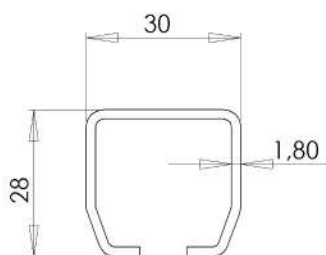

20 KG

**FESTOON SYSTEM
RUNNING ON A
C-PROFILE 30 X 28MM**

Max cable package: 58 (L) x 20 (H) mm

2331





GENERAL SALES CONDITIONS, SUPPLY AND WARRANTY

Generalities

The supply of the products contained in this catalogue is subject to the conformity of the tariff in force at the moment and the terms contained in these General Conditions of Sale and Guarantees.

Orders and prices

All orders received by IGA will be confirmed via fax or email. If in the following 24 hours IGA does not receive any claim, they will be considered definitive. IGA reserves the right to accept or reject any order.

Codes

The codes indicated in this catalogue are the standard products of IGA.

Delivery time

If for reasons beyond our control we can not fulfill this service commitment, IGA will inform the customer of the new term within a maximum of 48 hours after the reception of the order.

The rest of references will be served in the shortest period of time possible and may make partial deliveries.

Orders received that have a delivery time less than 72 hours, will follow the procedure described above.

The breach of the previous commitment or a fractioned issue will not be grounds for compensation.

Transport

Our products are considered expired in our warehouse and the date of issue is shown on the delivery note.

The goods travels at the addressee expense and risk, even if they are sent prepaid.

In the case of lack of packages or visible damages due to transportation, the addressee must write it down on the delivery note, claim the carrier and inform the commercial department of IGA within 48 hours. Otherwise, it will be considered the conformity of the goods in quantity and condition. Claims for delays in transportation will not be accepted.

After 8 days from receipt of the goods, no claims will be accepted about the contents of the boxes.

Refunds

The products invoiced by IGA are considered a firm sale and has no right to refund.

In case of an error in the execution of the order, the following shall be taken into account:

- The change must be authorized by the comercial direction of IGA. The warehouse of IGA will not accept any product without authorization.

- The accepted material will have a 20% reduction of its value for verification expenses.

- The goods returned to IGA travel at the client's risk.

Installations

IGA is exempted from any responsibility in the installations that do not comply with the advice or with the specifications and features of each range of product.

Warranty

IGA range of products has a 2 year warranty. The acknowledgment of the responsibility in warranty corresponds only to IGA and / or to its insurance company. Any other defect caused by aging, corrosion, improper installation or improper application, will not be subject to possible claims.

Jurisdiction

IGA will try to resolve any divergence with his clients through friendly channels. Having said that, in case of litigation, the parties agree and are obliged to submit to the arbitration appointed by the Court of the Arbitration Association of Bilbao, which will be responsible for the administration of the aforementioned arbitration in accordance with its Statute and Regulations. Likewise, they are obliged from now on to comply with the arbitral report that is issued.

IGA reserves the modification of the articles without previous notice.

NOTES OF INTEREST

KIT FESTOON:

IGA offers the possibility of supplying the entire FESTOON system assembled under the customer's specifications.



KIT FESTOON

QUICK ASSEMBLY NUTS:

New QUICK polyamide nuts 6.6. that accelerate the operation of assembly of electric cables in trolleys; since these nuts are inserted in the screws until almost the final tightening zone.

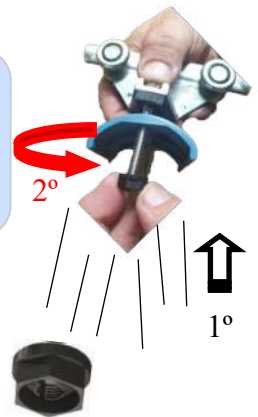

SQUARE NECK SCREWS:

The trolleys with body of sheet steel (series 2324), have been modified for the use of fixing screws with spherical head and square neck (according to DIN 603). The square neck prevents the screw from turning during the tightening process of the hexagonal nut of the carriage, so fewer tools are necessary and the assembly time is reduced.



FINAL PLUGS FOR THE PROFILE:

The option of plastic material caps to close both ends of the rolling profile has been added to our catalogue.

NOTE: The CM brackets have these series plugs incorporated.

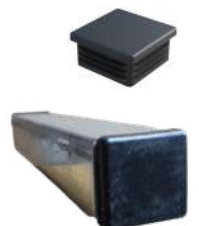

Twitter
@indgalarza



Facebook
Industrias Galarza, S.A.



LinkedIn
Industrias Galarza, S.A.



FESTOON SYSTEM SERIES 2331

INDEX

Profile	Page. 03	ROUND CABLE TROLLEY	
Joint	Page. 03	End clamp	Page. 09
Hanger	Page. 03	Cable trolley	Page. 09
FLAT CABLE TROLLEY		Towing trolley	Page. 09
End clamp	Page. 04	Cable holders & "T" union	Page. 09-10
Cable trolley	Page. 05-06	Carrying trolleys	Page. 10
Towing trolley	Page. 07	Assembly set	Page. 11
Pendant control unit trolley	Page. 08	Accessories	Page. 12
		Assembly instructions	Page. 13-14

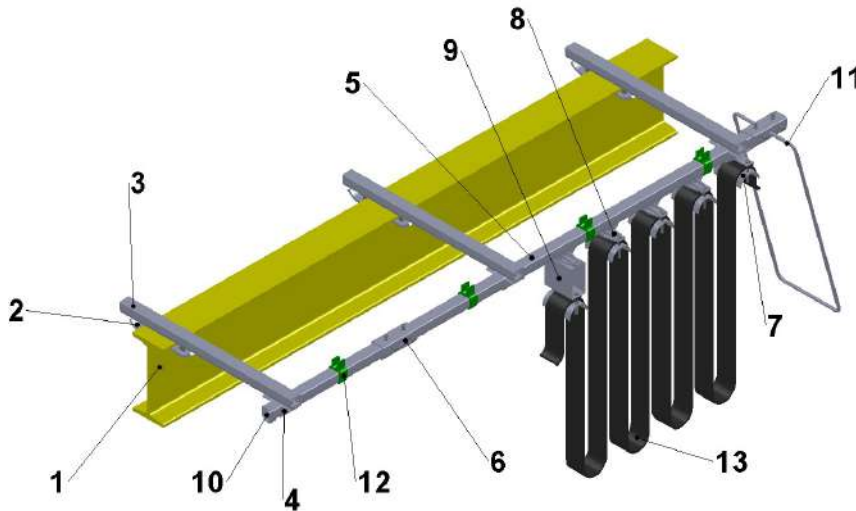

1. Beam
2. Beam clip
3. Cross arm support
4. Track hanger
5. Track profile
6. Track joint
7. End clamp
8. Cable trolley
9. Towing trolley
10. End bumper stop
11. Protection
12. Cable clamp
13. Cable

Maximum cable package: 58 (L) X 20 (H) mm.

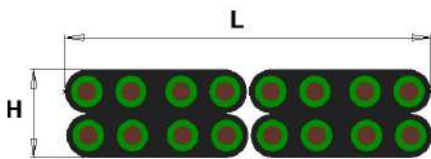

In aggressive indoor / outdoor conditions the metal components (bodies and cable holders) are supplied with EPOXY paint or made in stainless steel AISI 304.

TEMPERATURE RANGE: -15°C / +80°C.

MAX. LOAD CAPACITY PER TROLLEY = 20

NUMBER OF TROLLEYS REQUIRED:

$$N = (L / 2xH) - 1$$

Where: N: number of cable trolleys
L: travelling length
H: maximum loop height

REQUIRED AMBUSH LENGTH

$$b = (N + 1) x m$$

Where: b: maximum ambush length
N: number of cable trolleys
m: trolley length



FESTOON SYSTEM SERIES 2331

PROFILE

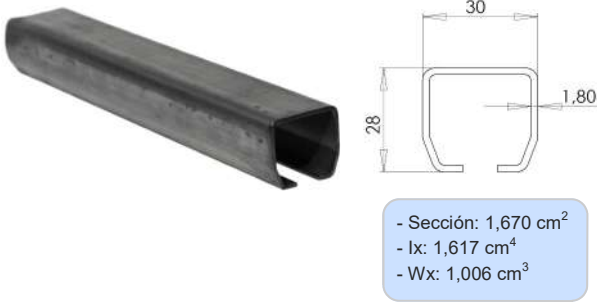

REFERENCE	CODE	MATERIAL	LENGTH	WEIGHT
2331-1	302001	Galvanised Steel	5 mts	1,30 Kg/m
2331-1	302612	Galvanised Steel	2,5 Mts	1,30 Kg/m
2331-1-Inox	302300	Stainless Steel AISI 316	5 mts	1,30 Kg/m

TRACK JOINT 3

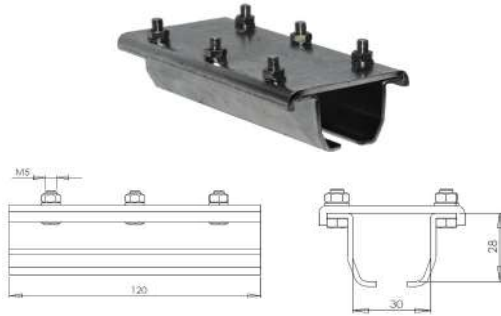

REFERENCE	CODE	MATERIAL		WEIGHT
		Laterals	Screws	
2331-3	302003	Zinc Plated Steel	Zinc Plated Steel	0,375 Kg
2331-3-PLY	302369	Painted Steel	Stainless Steel	0,385 Kg
2331-3-Inox	302269	Stainless Steel	Stainless Steel	0,375 Kg

TRACK JOINT 3-E

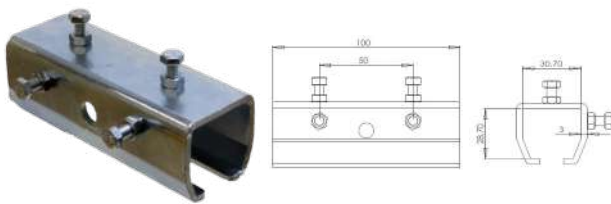

REFERENCE	CODE	MATERIAL		WEIGHT
		Body	Screws	
2331-3-E	302410	Zinc Plated Steel	Zinc Plated Steel	0,259 Kg
2331-3-E-PLY	302514	Painted Steel	Stainless Steel	0,269 Kg
2331-3-E-Inox	302519	Stainless Steel	Stainless Steel	0,259 Kg

HORIZONTAL TRACK HANGER BRACKET



REFERENCE	CODE	MATERIAL		WEIGHT
		Body	Screws	
2331-4-A	302005	Zinc Plated Steel	Zinc Plated Steel	0,112 Kg
2331-4-A-Inox	302559	Stainless Steel	Stainless Steel	0,112 Kg

CEILING TRACK HANGER BRACKET

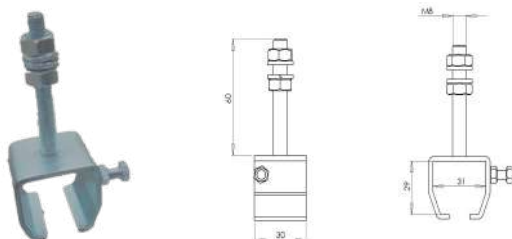

REFERENCE	CODE	MATERIAL		WEIGHT
		Body	Screws	
2331-4-A-R	302288	Zinc Plated Steel	Zinc Plated Steel	0,099 Kg
2331-4-A-R-Inox	302420	Stainless Steel	Stainless Steel	0,099 Kg

HORIZONTAL TRACK HANGER BRACKET

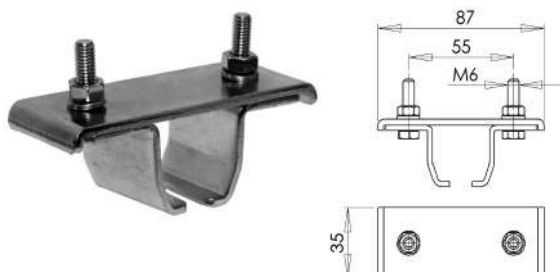

REFERENCE	CODE	MATERIAL		WEIGHT
		Base + Laterals	Screws	
2331-4	302004	Zinc Plated Steel	Zinc Plated Steel	0,165 Kg
2331-PLY	302370	Painted Steel	Stainless Steel	0,175 Kg
2331-4-Inox	302270	Stainless Steel	Stainless Steel	0,165 Kg



FESTOON SYSTEM SERIES 2331

LATERAL TRACK HANGER

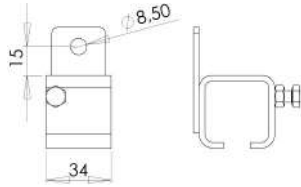

REFERENCE	CODE	MATERIAL		WEIGHT
		BODY	SCREWS	
2300/R-4-L	302306	Zinc Plated Steel	Zinc Plated Steel	0,155 Kg
2300/R-4-L-Inox	302560	Stainless Steel	Stainless Steel	0,155 Kg

END CLAMP

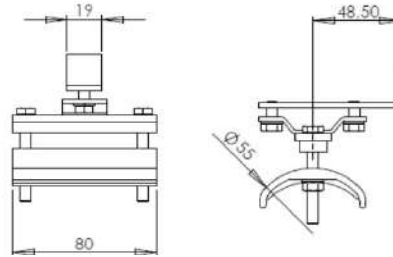

SADDLES Ø85mm IN STEEL ARE AVAILABLE

REFERENCE	CODE	MATERIAL			WEIGHT
		Body	Screws	Saddle	
2331-2	302002	Zinc Plated Steel	Zinc Plated Steel	Polypropylene	0,170 Kg
2331-C-2	302010	Zinc Plated Steel	Zinc Plated Steel	Zinc Plated Steel	0,315 Kg
2331-2-PLY	302520	Painted Steel	Stainless Steel	Polypropylene	0,180 Kg
2331-C-2-PLY	302522	Painted Steel	Stainless Steel	Painted Steel	0,325 Kg
2331-2-Inox	302521	Stainless Steel	Stainless Steel	Polypropylene	0,170 Kg
2401-C-2-Inox	302523	Stainless Steel	Stainless Steel	Stainless Steel	0,315 Kg
2331-2-TR	302581	Zinc Plated Steel	Zinc Plated Steel	Polypropylene	0,170 Kg
2331-2-PLY-TR	302582	Painted Steel	Stainless Steel	Polypropylene	0,180 Kg
2331-2-Inox-TR	302603	Stainless Steel	Stainless Steel	Polypropylene	0,170 Kg

Trolley assembled with QUICK nut

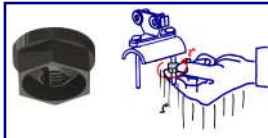

END CLAMP

Saddle ø55mm

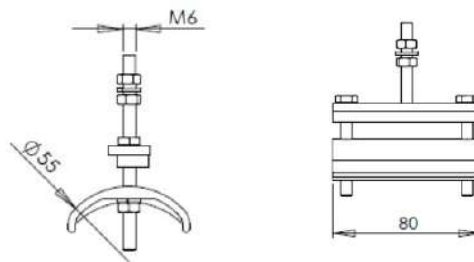

SADDLES Ø85mm IN STEEL ARE AVAILABLE

REFERENCE	CODE	MATERIAL			WEIGHT
		Body	Screws	Saddle	
2331-2S	302339	Zinc Plated Steel	Zinc Plated Steel	Polypropylene	0,115 Kg
2331-CH-2S	302359	Zinc Plated Steel	Zinc Plated Steel	Zinc Plated Steel	0,315 Kg
2331-2S-PLY	302524	Painted Steel	Stainless Steel	Polypropylene	0,125 Kg
2331-CH-2S-PLY	302525	Painted Steel	Stainless Steel	Painted Steel	0,325 Kg
2331-2S-Inox	302526	Stainless Steel	Stainless Steel	Polypropylene	0,115 Kg
2331-CH-2S-Inox	302527	Stainless Steel	Stainless Steel	Stainless Steel	0,315 Kg
2331-2S-TR	302583	Zinc Plated Steel	Zinc Plated Steel	Polypropylene	0,115 Kg
2331-2S-PLY-TR	302584	Painted Steel	Stainless Steel	Polypropylene	0,125 Kg
2331-2S-Inox-TR	302604	Stainless Steel	Stainless Steel	Polypropylene	0,115 Kg

Trolley assembled with QUICK nut





FESTOON SYSTEM SERIES 2331

CABLE TROLLEY

Saddle $\varnothing 55\text{mm}$

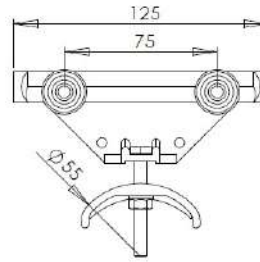
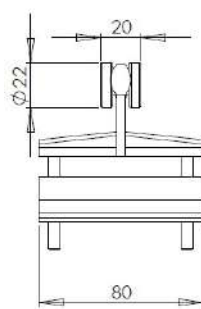

SADDLE $\varnothing 85\text{mm}$ IN STEEL ARE AVAILABLE

REFERENCE	CODE	MATERIAL			WEIGHT
		Body	Screws + Wheels	Saddle	
2400-5	302047	Aluminium	Zinc Plated Steel	Polypropylene	0,186 Kg
2400-C-5	302053	Aluminium	Zinc Plated Steel	Zinc Plated Steel	0,264 Kg
2400-5 PLY	302068	Painted Aluminium	Stainless Steel	Polypropylene	0,196 Kg
2400-C-5-PLY	302074	Painted Aluminium	Stainless Steel	Painted Steel	0,274 Kg
2400-5-TR	302585	Aluminium	Zinc Plated Steel	Polypropylene	0,186 Kg
2400-5-PLY-TR	302586	Painted Aluminium	Stainless Steel	Polypropylene	0,196 Kg

Trolley assembled with QUICK nut



CABLE TROLLEY

Saddle $\varnothing 55\text{mm}$

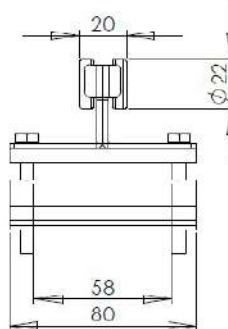
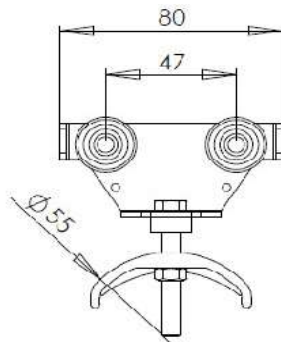

DIN603 spherical head and square neck screw

REFERENCE	CODE	MATERIAL			WEIGHT
		Body	Screws + Wheels	Saddle	
2401-5	302090	Zinc Plated Steel	Zinc Plated Steel	Polypropylene	0,190 Kg
2401-C-5	302096	Zinc Plated Steel	Zinc Plated Steel	Zinc Plated Steel	0,264 Kg
2401-5 PLY	302105	Painted Steel	Stainless Steel	Polypropylene	0,200 Kg
2401-C-5-PLY	302011	Painted Steel	Stainless Steel	Painted Steel	0,274 Kg
2401-5-Inox	302357	Stainless Steel	Stainless Steel	Polypropylene	0,190 Kg
2401-CH-5-Inox	302271	Stainless Steel	Stainless Steel	Stainless Steel	0,264 Kg
2401-5-TR	302587	Zinc Plated Steel	Zinc Plated Steel	Polypropylene	0,190 Kg
2401-5-PLY-TR	302588	Painted Steel	Stainless Steel	Polypropylene	0,200 Kg
2401-5-Inox-TR	302605	Stainless Steel	Stainless Steel	Polypropylene	0,190 Kg

Trolley assembled with QUICK nut





FESTOON SYSTEM SERIES 2331

CABLE TROLLEY

Saddle $\varnothing 55\text{mm}$



2332-5



2332-C-5



2332-L-5



2332-LC-5

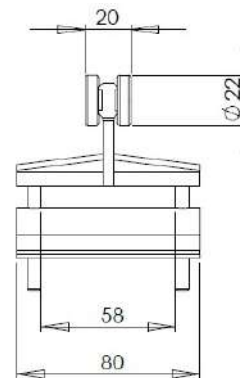
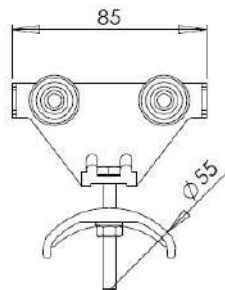

Trolley assembled with QUICK nut



REFERENCE	CODE	MATERIAL				MAX. LOAD	WEIGHT
		Body	Wheels	Saddle	Screws		
2332-5	302029	Polypropylene	Polypropylene	Polypropylene	Zinc Plated steel	12 Kg	0,100 Kg
2332-C-5	302033	Polypropylene	Polypropylene	Zinc Plated Steel	Zinc Plated Steel	12 Kg	0,160 Kg
2332-L-5	302036	Polypropylene	Zinc Plated Steel	Polypropylene	Zinc Plated Steel	15 Kg	0,139 Kg
2332-LC-5	302037	Polypropylene	Zinc Plated Steel	Zinc Plated Steel	Zinc Plated Steel	15 Kg	0,216 Kg
2332-5-Inox	302528	Polypropylene	Polypropylene	Polypropylene	Stainless Steel	12 Kg	0,100 Kg
2332-C-5 Inox	302529	Polypropylene	Polypropylene	Stainless Steel	Stainless Steel	12 Kg	0,160 Kg
2332-L-5-Inox	302325	Polypropylene	Stainless Steel	Polypropylene	Stainless Steel	15 Kg	0,139 Kg
2332-LC-5-Inox	302530	Polypropylene	Stainless Steel	Stainless Steel	Stainless Steel	15 Kg	0,216 Kg
2332-5-TR	302589	Polypropylene	Polypropylene	Polypropylene	Zinc Plated Steel	12 Kg	0,100 Kg
2332-L-5-TR	302590	Polypropylene	Zinc Plated Steel	Polypropylene	Zinc Plated Steel	15 Kg	0,139 Kg
2332-5-Inox-TR	302591	Polypropylene	Polypropylene	Polypropylene	Stainless Steel	12 Kg	0,100 Kg
2332-L-5-Inox-TR	302592	Polypropylene	Stainless Steel	Polypropylene	Stainless Steel	15 Kg	0,139 Kg



FESTOON SYSTEM SERIES 2331

TOWING TROLLEY

Saddle $\varnothing 55\text{mm}$

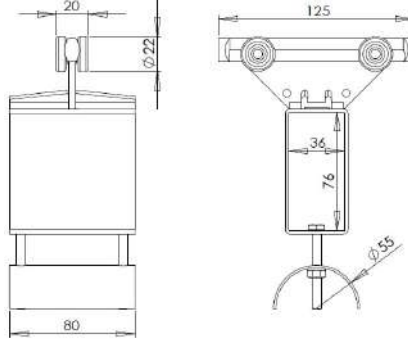

SADDLE $\varnothing 85\text{mm}$ IN ZINC PLATED STEEL ARE AVAILABLE

REFERENCE	CODE	MATERIAL				WEIGHT
		Body	Screws + Wheels	Towing Attachment	Saddle	
2400-6	302048	Aluminium	Zinc Plated Steel	Zinc Plated Steel	Polypropylene	0,480 Kg
2400-C-6	302054	Aluminium	Zinc Plated Steel	Zinc Plated Steel	Zinc Plated Steel	0,435 Kg
2400-6-PLY	302069	Painted Aluminium	Stainless Steel	Painted Steel	Polypropylene	0,480 Kg
2400-C-6 PLY	302075	Painted Aluminium	Stainless Steel	Painted Steel	Painted Steel	0,435 Kg
2400-6-TR	302593	Aluminium	Zinc Plated Steel	Zinc Plated Steel	Polypropylene	0,480 Kg
2400-6-PLY-TR	302594	Painted Aluminium	Stainless Steel	Zinc Plated Steel	Polypropylene	0,480 Kg

Trolley assembled with QUICK nut



TOWING TROLLEY

Saddle $\varnothing 55\text{mm}$

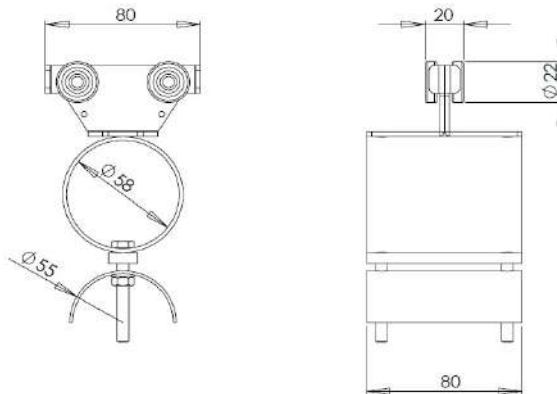

REFERENCE	CODE	MATERIAL				WEIGHT
		Body	Screws + Wheels	Towing Attachment	Saddle	
2401-6	302091	Zinc Plated Steel	Zinc Plated Steel	Zinc Plated Steel	Polypropylene	0,365 Kg
2401-C-6	302097	Zinc Plated Steel	Zinc Plated Steel	Zinc Plated Steel	Zinc Plated Steel	0,425 Kg
2401-6-PLY	302106	Painted Steel	Stainless Steel	Painted Steel	Polypropylene	0,375 Kg
2401-C-6-PLY	302112	Painted Steel	Stainless Steel	Painted Steel	Painted Steel	0,435 Kg
2401-6-Inox	302310	Stainless Steel	Stainless Steel	Stainless Steel	Polypropylene	0,365 Kg
2401-C-6-Inox	302321	Stainless Steel	Stainless Steel	Stainless Steel	Stainless Steel	0,425 Kg
2401-6-TR	302595	Zinc Plated Steel	Zinc Plated Steel	Zinc Plated Steel	Polypropylene	0,365 Kg
2401-6-PLY-TR	302596	Painted Steel	Stainless Steel	Painted Steel	Polypropylene	0,375 Kg
2401-6-Inox-TR	302606	Stainless Steel	Stainless Steel	Stainless Steel	Polypropylene	0,365 Kg

Trolley assembled with QUICK nut





FESTOON SYSTEM SERIES 2331

PENDANT CONTROL UNIT TROLLEY

Saddle ø55mm

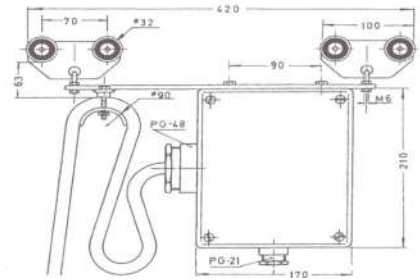

REFERENCE	CODE	MATERIAL					WEIGHT
		Body	Screws + Wheels	Saddle	Junction box	Cable gland	
2331-7	302008	Zinc Plated Steel	Zinc Plated Steel	Polypropylene	Polyester & Glass Fiber	Polyamide	2,360 Kg
2331-C-7	302013	Zinc Plated Steel	Zinc Plated Steel	Zinc Plated Steel	Polyester & Glass Fiber	Polyamide	2,450 Kg
2331-7-Inox	302356	Stainless Steel	Stainless Steel	Polypropylene	Polyester & Glass Fiber	Polyamide	2,360 Kg
2331-CH-7-Inox	302377	Stainless Steel	Stainless Steel	Stainless Steel	Polyester & Glass Fiber	Polyamide	2,450 Kg
2331-7-TR	302597	Zinc Plated Steel	Zinc Plated Steel	Polypropylene	Polyester + Glass Fiber	Polyamide	2,360 Kg
2331-7-Inox-TR	302598	Stainless Steel	Stainless Steel	Polypropylene	Polyester + Glass Fiber	Polyamide	2,360 Kg

Trolley assembled with QUICK nut



QUICK DISCONNECT PENDANT CONTROL UNIT TROLLEY

Saddle ø55mm

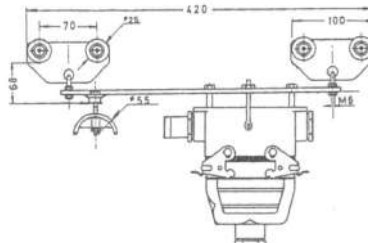

16 Poles Multipole Connector
(1 Cable Entry PG-21)

24 Poles Multipole Connector
(2 Cables Entry PG-21)

REFERENCE	CODE	MATERIAL					WEIGHT
		Body	Screws + Wheels	Saddle	Multipole Connector	Cable Gland	
2331-7-C16	302231	Zinc Plated Steel	Zinc Plated Steel	Polypropylene	Formed Aluminium	Polyethylene	2,328 Kg
2401-C-7-C16	302531	Zinc Plated Steel	Zinc Plated Steel	Zinc Plated Steel	Formed Aluminium	Polyethylene	2,423 Kg
2331-7-C24	302236	Zinc Plated Steel	Zinc Plated Steel	Polypropylene	Formed Aluminium	Polyethylene	2,779 Kg
2401-C-7-C24	302532	Zinc Plated Steel	Zinc Plated Steel	Zinc Plated Steel	Formed Aluminium	Polyethylene	2,874 Kg
2401-C-7-C16-Inox	302533	Stainless Steel	Stainless Steel	Stainless Steel	Formed Aluminium	Polyethylene	2,423 Kg
2401-C-7-C24-Inox	302534	Stainless Steel	Stainless Steel	Stainless Steel	Formed Aluminium	Polyethylene	2,874 Kg
2331-7-C16-TR	302599	Zinc Plated Steel	Zinc Plated Steel	Polypropylene	Formed Aluminium	Polyethylene	2,328 Kg
2331-7-C24-TR	302601	Zinc Plated Steel	Zinc Plated Steel	Polypropylene	Formed Aluminium	Polyethylene	2,779 Kg

Trolley assembled with QUICK nut





SERIES 2331 SUPPORT SADDLE FOR ROUND CABLES AND HOSES



END CLAMP

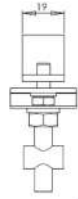
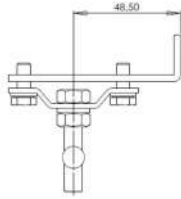

REFERENCE	CODE	MATERIAL	MAX. LOAD	WEIGHT
2338-2	302280	Zinc Plated Steel	20 Kg	0,136 Kg
2338-2-Inox	302535	Stainless Steel	20 Kg	0,136 Kg

CABLE TROLLEY

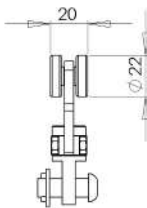
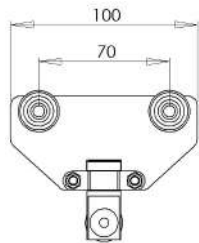

REFERENCE	CODE	MATERIAL	MAX. LOAD	WEIGHT
2338-5	302211	Zinc Plated Steel	20 Kg	0,308 Kg
2338-5-Inox	302536	Stainless Steel	20 Kg	0,308 Kg

TOWING TROLLEY

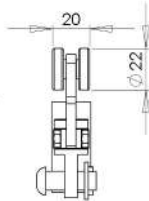
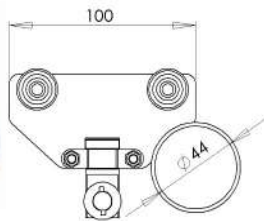

REFERENCE	CODE	MATERIAL	MAX. LOAD	WEIGHT
2338-6	302327	Zinc Plated Steel	20 Kg	0,369 Kg
2338-6-Inox	302537	Stainless Steel	20 Kg	0,369 Kg

CLIP "+A" for cables from $\varnothing 8\text{mm}$ to $\varnothing 15\text{mm}$

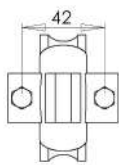

REFERENCE	CODE	MATERIAL	SCREWS	WEIGHT
+A	303251	Aluminium	Zinc Plated Steel	0,104 Kg
+A-Inox	303596	Aluminium	Stainless Steel	0,104 Kg

CLIP "+B" for cables from $\varnothing 16\text{mm}$ to $\varnothing 24\text{mm}$

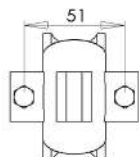

REFERENCE	CODE	MATERIAL	SCREWS	WEIGHT
+B	303252	Aluminium	Zinc Plated Steel	0,114 Kg
+B-Inox	303597	Aluminium	Stainless Steel	0,114 Kg

CLIP "+C" for cables from $\varnothing 25\text{mm}$ to $\varnothing 35\text{mm}$

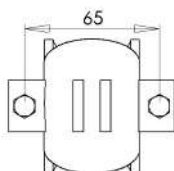

REFERENCE	CODE	MATERIAL	SCREWS	WEIGHT
+C	303253	Stainless Steel	Zinc Plated Steel	0,150 Kg
+C-Inox	303598	Stainless Steel	Stainless Steel	0,150 Kg



SERIES 2331 SUPPORT SADDLE FOR ROUND CABLES AND HOSES



"T" UNION

REFERENCE	CODE	MATERIAL	SCREWS + RIVETS	WEIGHT
T	303496	Stainless Steel	Zinc Plated Steel	0,107 Kg
T-Inox	303599	Stainless Steel	Stainless Steel	0,107 Kg

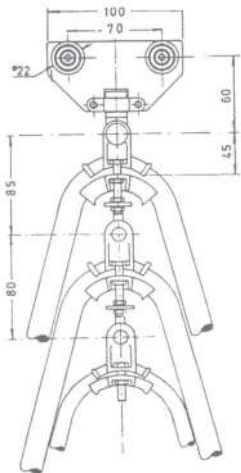
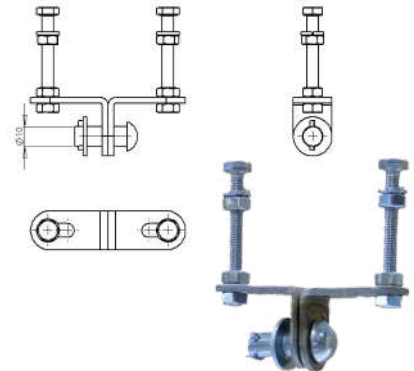

Cable Trolley - Ref. 2.338 + C + B + A - 5

The clips makes a 90 degree turn in order to make easier the parking. When ordering, add to the reference, the necessary clips, followed by the indicative number: end clamp (-2), cable trolley (-5) or towing trolley (-6).

- Example:
- End clamp 2338+C+B-2.
 - Cable trolley 2338+B+B+A+5.
 - Towing trolley 2338+A-6.

SERIES 2300R CARRYING TROLLEYS

SINGLE AXLE CARRYING TROLLEY

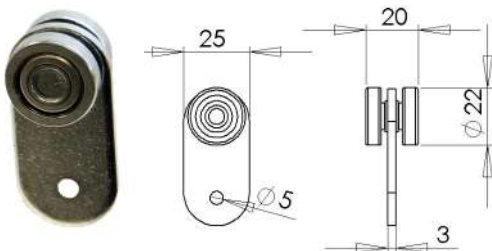

REFERENCE	CODE	MATERIAL		MAX LOAD	WEIGHT
		Body	Bearings + Shaft		
2330-22	302041	Zinc Plated Steel	Zinc Plated Steel	10 Kg	0,060 Kg
2330-22-PLY	302538	Painted Steel	Stainless Steel	10 Kg	0,070 Kg
2330-22-Inox	302436	Stainless Steel	Stainless Steel	10 Kg	0,060 Kg

DOUBLE AXLE CARRYING TROLLEY

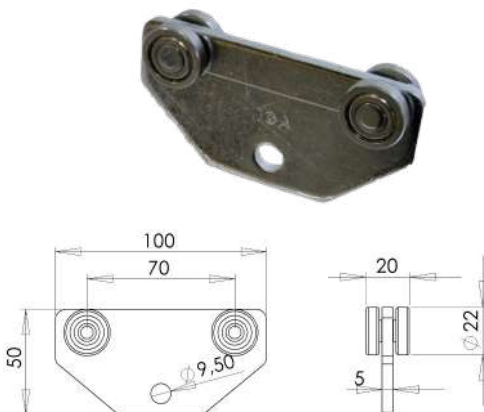

REFERENCE	CODE	MATERIAL		MAX LOAD	WEIGHT
		Body	Bearings + Shaft		
2330-D-22	302116	Zinc Plated Steel	Zinc Plated Steel	20 Kg	0,220 Kg
2330-D-22-PLY	302539	Painted Steel	Stainless Steel	20 Kg	0,230 Kg
2330-D-22-Inox	302435	Stainless Steel	Stainless Steel	20 Kg	0,220 Kg



STANDARD BRACKET FOR SERIES 2331



Cross support arm options:
 - Profile 2331-1 (30x28mm): CM-2.
 - Profile 2500-1 (40x35mm): CM-3.

REFERENCE	CODE	MATERIAL			WEIGHT
		Track Support	Beam Claws	Support Arm	
CM-2	—	Zinc Plated Steel	Zinc Plated Steel	Galvanised Steel	—
CM-2-Inox	—	Stainless Steel	Stainless Steel	Stainless Steel	—
CM-3	—	Zinc Plated Steel	Zinc Plated Steel	Galvanised Steel	—
CM-3-Inox	—	Stainless Steel	Stainless Steel	Stainless Steel	—

Once we have chosen the cross support arm, point out the total length (L) of it. Example:
 - CM-2-500.
 - CM-3-500.

Brackets formed by:
 - 1 cross support arm 2331-1 (L) or 2500-1 (L).
 - 2 beam claws.
 - 1 track holder 2340-13

TRACK HOLDER

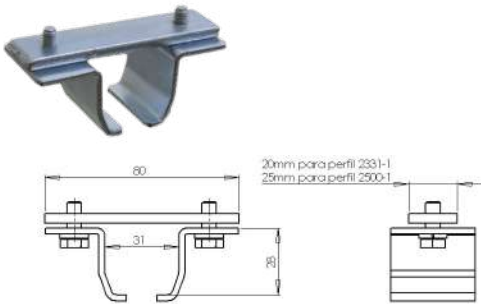

FOR ARM	REFERENCE	CODE	MATERIAL	WEIGHT
For 2331-1 profile	2340-13-31-R1	309002	Zinc Plated Steel	0,142 Kg
For 2500-1 profile	2340-13-500-R1	309003	Zinc Plated Steel	0,164 Kg
For 2331-1 Inox profile	2340-13-31-R1-Inox	309235	Zinc Plated Steel	0,142 Kg
For 2500-1 Inox profile	2340-13-500-R1-Inox	309341	Stainless Steel	0,164 Kg

ADJUSTABLE TRACK HANGER BRACKET WITH LOCK

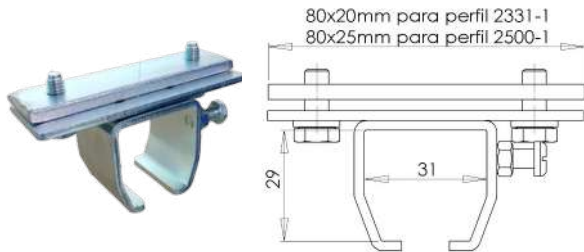

FOR ARM	REFERENCE	CODE	MATERIAL	WEIGHT
For 2331-1 profile	2331-4-A-31	309323	Zinc Plated Steel	0,220 Kg
For 2500-1 profile	2331-4-A-500	302212	Zinc Plated Steel	0,260 Kg
For 2331-1 Inox profile	2331-4-A-31-Inox	309453	Stainless Steel	0,220 Kg
For 2500-1 Inox profile	2331-4-A-500-Inox	309454	Stainless Steel	0,260 Kg

BEAM CLAWS



FOR ARM	REFERENCE	CODE	MATERIAL		WEIGHT
			Body	Screws	
For 2331-1 profile	2340-12	309005	Zinc Plated Steel	Zinc Plated Steel	0,140 Kg
For 2500-1 profile	2340-12-500	309006	Zinc Plated Steel	Zinc Plated Steel	0,156 Kg
For 2331-1 Inox profile	2340-12-Inox	309321	Stainless Steel	Stainless Steel	0,140 Kg
For 2500-1 Inox profile	2340-12-500-Inox	309316	Stainless Steel	Stainless Steel	0,156 Kg

WELD-ON BRACKET FOR SUPPORT ARM

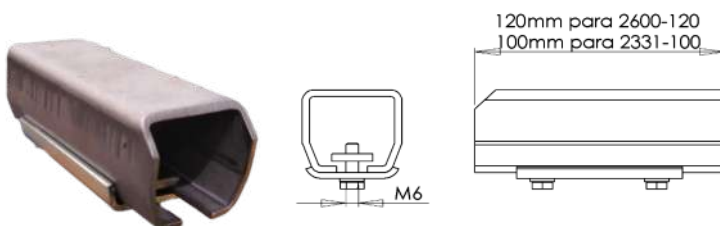

FOR ARM	REFERENCE	CODE	MATERIAL	WEIGHT
2331-1	2331-100	302561	Steel	0,370 Kg
2500-1	2600-120	310011	Steel	0,584 Kg



ACCESSORIES

END BUMPER STOP

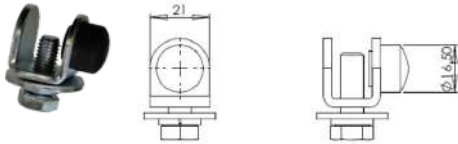

REFERENCE	CODE	MATERIAL			WEIGHT
		Body	Screws	Buffer	
2309-2	302118	Zinc Plated Steel	Zinc Plated Steel	Rubber	0,048 Kg
2309-2-PLY	303507	Painted Steel	Stainless Steel	Rubber	0,048 Kg
2309-2-Inox	302449	Stainless Steel	Stainless Steel	Rubber	0,058 Kg

JOINT + LOOP PROTECTION STOP

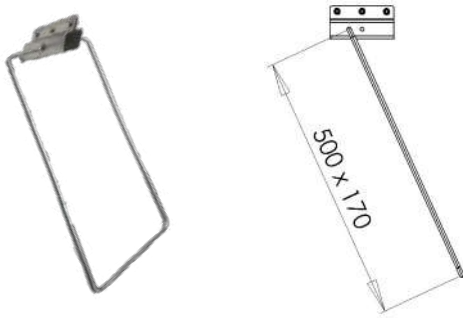

REFERENCE	CODE	MATERIAL	WEIGHT
2331-3-C	302246	Zinc Plated Steel	0,935 Kg

CLAMPS FOR ROUND CABLE AND HOSES



2331-SC-1 2331-SC-2 2331-SC-3

REFERENCE	CODE	MATERIAL	CABLES	WEIGHT
2331-SC-1	302221	Polypropylene with glass fiber	2xø15mm	0,013 Kg
2331-SC-2	302241	Polypropylene with glass fiber	1xø13mm / 1xø18mm	0,008 Kg
2331-SC-3	302247	Polypropylene with glass fiber	2xø15mm	0,011 Kg

CLAMP B

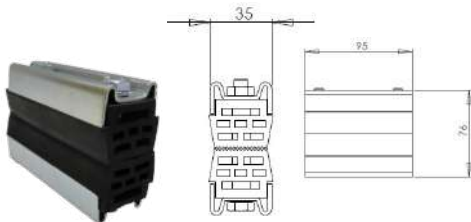

REFERENCE	CODE	MATERIAL				WEIGHT
		Metal Section	Tightening profile	Nuts	Bolts	
B-58	302009	Zinc Plated Steel	Rubber	Brass	Zinc Plated Steel	0,455 Kg
B-58(TI)	303343	Galvanized Steel	Rubber	Brass	Stainless Steel	0,455 Kg
B-58-Inox	302473	Stainless Steel	Rubber	Brass	Stainless Steel	0,455 Kg

"QUICK" NUT



REFERENCE	CODE	MATERIAL	WEIGHT	UNITS X BAG
TR	303642	Polyamide 6.6	0,005 kg	50

END CAPS

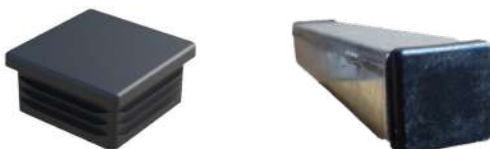

FOR PROFIL	REFERENCE	CODE	MATERIAL	WEIGHT
2331-1	2331-EC	302572	Black polyethylene	0,004 Kg
2500-1	2500-EC	305474	Black polyethylene	0,006 Kg



ASSEMBLY INSTRUCTIONS

1) SECURITY

1.1 Advices about electricity

- Disconnect the power from the system before starting any assembly operation.
- Do not use electrical cables for higher loads than the specified voltage and current.

1.2 Operational advices

- Do not use different cables for which the festoon system is specified. Any change in number, diameter, weight, etc., may affect the normal operation of the cable system.

1.3 Maintenance advice

- The modification of the number and/or characteristics of the festoon system components cancels the warranty.

2) INSTALLATION

The support structure for the festoon system must be capable of supporting the total weight of the festoon system. Place the support along the beam through which the hoist is to be circulated. These points must be located every 2m, except in the parking area where they must be located every 1m.



STANDARD BRACKETS



BEAM WELDED JOINT BAR



BEAM WELDED SUPPORT



Install the first profile in the supports 2331-4 without tightening the screws.



Assemble the next profile section on its corresponding supports 2331-4 in the same way as the first.



Join these profiles using the joints 2331-3 that guarantee a continuous travel between both sections. Tighten the screws once the joint has been placed in the middle of both profile sections. Repeat the same operation for the rest of the profile sections.

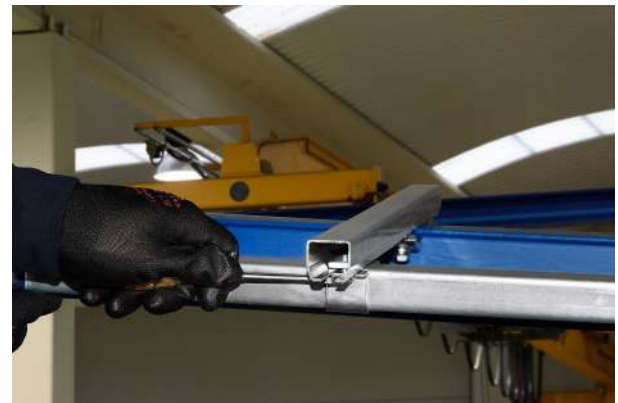

Once all the profiles have been assembled, we will proceed to align the path with respect to the rolling hoist on the beam, crane, etc. Once the alignment is correct, we will proceed to tighten the screws of the supports 2331-4.



ASSEMBLY INSTRUCTIONS



Cut the necessary length of electrical cable leaving enough length on both sides to make the electrical connections later. Make marks with white chalk on the cable in the required points, according to the height of the loop or number of trolleys to be assembled. Put the cables in the saddle (biggest cables should be mounted on top of the cable package).



Tighten the screws of the cable holders avoiding damaging the cables due to excessive tightening. The cable package should be as centered as possible on the cable holder, so that the trolley runs in a balanced way. Make sure that the smallest cables do not slip into the cable package.



Insert the festoon system into the profile, starting first with the towing trolley and then following the cable trolleys. Insert the end clamp last. The cables must be mounted without any rotation.



Tighten the end clamp at the end of the profile. Make the connections of the cables on both sides of the system in their respective connection boxes.

3) OPERATION

3.1 Previous tests

Carry out several travels by hand to check that it moves throughout its length without problems.

Check that there is plenty of space in the ambush area.

Check that the cable loops don't get hooked in any part of the travel.

In the cable management system, check the correct height between the pushbutton pendant control station and the floor.

3.2 Final tests

Once the electric current is connected, check that the trolleys move forward and backward without problems.

Check that the device, the festoon system is powered on, works correctly.

3.3 Normal functioning

Do not exceed the maximum voltage and / or amperage specified for the electric cables.

Use the festoon system within its corresponding electrical and / or mechanical specifications.

4) MAINTENANCE

Perform periodic maintenance tasks to ensure the status of the festoon system. The maintenance operations will depend on the use given to the system.

During each inspection the following points should be checked:









- Wear of ball bearings.
- Ensure screws are correctly tightened.
- Separation or alignment in the joints.
- Electric cables: cuts, cracks, etc...
- The profile must be clean in the running edges.















Industrias GALARZA, S.A.[®]

Leaders in electrical conductivity since 1958

RANGE OF PRODUCTS

			
Multipole enclosed conductor systems	Single pole enclosed conductor systems	Materials for unguarded conductor systems	Insulators and moulded pieces
			
Festoon systems	Atex	Cable glands and electric cables	Cable reels

MARKETS

CRANES 	PORTS&CONTAINERS HANDLING 	BULK MATERIAL HANDLING 	METALLURGY 
MINNING & ENERGY 	TUNNELLING 	ENVIRONMENTAL TECHNOLOGY 	WIND POWER 
AUTOMOTIVE 	OFFSHORE 	THEATRE STAGE TECH. 	AGRICULTURE 

INDUSTRIAS GALARZA S.A.
 P.I. Bidosola, Pab. D-4
 E-48142 ARTEA (BIZKAIA)
 SPAIN

Tel. +34 944 47 18 12
 Fax. +34 944 76 42 76

E.mail: info@industriasmgalarza.com
www.industriasmgalarza.com

DISTRIBUTED BY: