





Industrias GALARZA, S.A.®

Leaders in electrical conductivity since 1958

CATALOGUE 2020

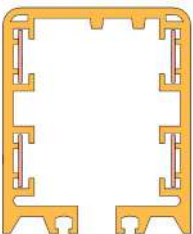
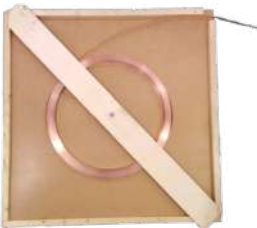

PVC HOUSING	DESCRIPTION	SERIES	SERIE
		PVC INSULATED 4 POLE CONDUCTOR SYSTEM “CONTINUES” FOR MOBILE POWER FEEDING	LC-4 



GENERAL SALES CONDITIONS, SUPPLY AND WARRANTY

Generalities

The supply of the products contained in this catalogue is subject to the conformity of the tariff in force at the moment and the terms contained in these General Conditions of Sale and Guarantees.

Orders and prices

All orders received by IGA will be confirmed via fax or email. If in the following 24 hours IGA does not receive any claim, they will be considered definitive. IGA reserves the right to accept or reject any order.

Codes

The codes indicated in this catalogue are the standard products of IGA.

Delivery time

If for reasons beyond our control we can not fulfill this service commitment, IGA will inform the customer of the new term within a maximum of 48 hours after the reception of the order.

The rest of references will be served in the shortest period of time possible and may make partial deliveries.

Orders received that have a delivery time less than 72 hours, will follow the procedure described above.

The breach of the previous commitment or a fractioned issue will not be grounds for compensation.

Transport

Our products are considered expired in our warehouse and the date of issue is shown on the delivery note.

The goods travels at the addressee expense and risk, even if they are sent prepaid.

In the case of lack of packages or visible damages due to transportation, the addressee must write it down on the delivery note, claim the carrier and inform the commercial department of IGA within 48 hours. Otherwise, it will be considered the conformity of the goods in quantity and condition . Claims for delays in transportation will not be accepted.

After 8 days from receipt of the goods, no claims will be accepted about the contents of the boxes.

Refunds

The products invoiced by IGA are considered a firm sale and has no right to refund.

In case of an error in the execution of the order, the following shall be taken into account:

-The change must be authorized by the comercial direction of IGA. The warehouse of IGA will not accept any product without authorization.

-The accepted material will have a 20% reduction of its value for verification expenses.

-The goods returned to IGA travel at the client's risk.

Installations

IGA is exempted from any responsibility in the installations that do not comply with the advice or with the specifications and features of each range of product.

Warranty

IGA range of products has a 2 year warranty. The acknowledgment of the responsibility in warranty corresponds only to IGA and / or to its insurance company. Any other defect caused by aging, corrosion, improper installation or improper application, will not be subject to possible claims.

Jurisdiction

IGA will try to resolve any divergence with his clients through friendly channels. Having said that, in case of litigation, the parties agree and are obliged to submit to the arbitration appointed by the Court of the Arbitration Association of Bilbao, which will be responsible for the administration of the aforementioned arbitration in accordance with its Statute and Regulations. Likewise, they are obliged from now on to comply with the arbitral report that is issued.

IGA reserves the modification of the articles without previous notice.

INDEX

APPLICATIONS AND FEATURES	Page. 02	Current collector	Page. 06
BASE COMPONENTS	Page. 03	Towing arm	Page. 06
PVC Housing	Page. 03	AUXILIARY COMPONENTS	Page. 07
Copper conductors	Page. 04	LC ASSEMBLY SCHEME	Page. 09
SYSTEM COMPONENTS	Page. 04	ASSEMBLY INSTRUCTIONS	Page. 09
PVC Housing	Page. 04		
Copper conductors	Page. 04		
Sliding hanger	Page. 04		
Joint	Page. 04		
Feeding box	Page. 05		
Connection bracket	Page. 05		
PVC connection profile	Page. 05		
End cap	Page. 05		
Fixed point clamp	Page. 05		



MODULAR CONDUCTOR SYSTEM LC-4

APPLICATIONS AND FEATURES

Protected electrical conduit, with movable current collector. Applied, for safety, as a mobile power supply with fixed travel (straight and curved) in: cranes, hoists, moving electric machines, moving equipment and, in general, where a mobile power outlet is needed.



Classification of the degree of protection Modular Line LC-4 (UNE 20-324-89, CEI 144, DIN 40050):

IP 23 / IP 44 with closing profile PC-4

The LC-4 line is suitable for use in high environmental dirt (dust, corrosive gases, etc.).

Presented on dielectric profile in PVC with four poles, "earth" line marked in yellow, in different versions according to intensities. With parallel assembly of several lines, more poles and higher intensities are obtained. Conductors freely housed in the profile, allow different expansions of copper and PVC, as well as the dissipation of heat caused by the Joule effect.

Possibility of mounting indoors and outdoors with service temperatures between -10°C and + 50°C for indoor and between -30°C and 60°C for outdoor.

For outdoor installation, the assembly scheme is different and the line components, with specific treatment and stainless screws, vary their references.

Special installations: lengths greater than 280m., mixed indoor-outdoor installations, etc. consult our Technical Service providing sketches and service conditions.

For installations with curved sections, dimensions drawing is required. Including the travel of the hoist running on the beam.

The smallest radius that can curved is 1m.



MODULAR CONDUCTOR SYSTEM LC-4

BASE COMPONENTS

PVC HOUSING

Composition: Rigid auto-extinguishable PVC (UNE 20.672.83) complies with the specific conditions of the standard UNE 21-0995 part. 9.8.1. on thermoplasticity to 70°C severity.

DIELECTRIC CHARACTERISTICS

Dielectric Strength.....25 Kv/mm.
Transverse Resistivity..... 1x10xΩ/cm.

MECHANICAL CHARACTERISTICS

Bending Strength.....780 Kgs/cm².
Tensile Strength.....≥540 Kgs/cm².
Impact Resistance (DIN 53453).....No Failure.

SERVICE TEMPERATURES

Continuous Operation.....between -30°C y +60°C.
Softening Point (VICAT).....80°C.

DENSITY.....1,49±0,02gr/cm³.

EXPANSION COEFICIENT.....0,05mm/m/°C.

RESISTANCE TO CHEMICAL AGENTS

Oils and Greasy Minerals..... YES.
Solvents: all except aromatical cetanic and chlorinated solvents.
Hydrochloric acid.....NO.
Sulphuric acid diluted to 50%.....YES.
Concentrated Sulphuric Acid.....NO.
Caustic soda at 50%.....Yes to ≤ 40°C.

INFLAMMABILITY

Self extinguishing, fire resistant material.

WATER ABSORPTION

Undetectable.....<0,07%.

CONDUCTORS

Fabricated in electrolytic copper straps, conforming to the standard DIN 1787 / 17670 / 40500 and quality CU-ETP certification.

Density: 8,9 gr/cm³.

Expansion coefficient: 0,0165mm/m/°C.

Conductivity IACS:100.

REF.	INTENSITY Amp.	VOLTAGE V	IMPEDANCE (Z) Ω/m	SECTION mm ²	Distance between conductors mm	Voltage Drop V/m/Amp
LM-40	40	500	2,00x10 ⁻³	9,0	15	0,00346
LM-60	60	500	1,75x10 ⁻³	12,0	15	0,00303
LM-80	80	500	1,18x10 ⁻³	16,5	15	0,00204
LM-100	100	500	1,00x10 ⁻³	21,0	15	0,00173
LM-140	140	500	0,75x10 ⁻³	30,0	15	0,00123
LM-160	160	500	0,65x10 ⁻³	37,5	15	0,00105
LM-200	200	500	0,55x10 ⁻³	52,5	15	0,00090

Values of voltage drop are considered at 20°C y cos φ:1, E.D. 80% in altern three-phase current.

- With temperatures of 30°C (86°F), apply correction factor 1,04.
- With temperatures of 40°C (104°F), apply correction factor 1,08.
- With temperaturas of 50°C (122°F), apply correction factor 1,12.

Consumption values at 60% E.D., apply correction factor 0,77.



MODULAR CONDUCTOR SYSTEM LC-4

SYSTEM COMPONENTS

PVC HOUSING



Indoor

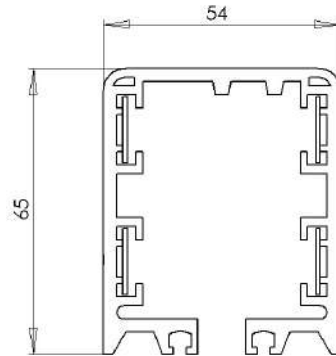

Outdoor or aggressive environments

TEMPERATURE RANGE: -10°C / +50°C.

Standard length: 4 mts.

Number of conductors: 4

TEMPERATURE RANGE: -30°C / +60°C.

ENVIRONMENT	REFERENCE	CODE	WEIGHT
INDOOR	PVC-4C	213651	1, 170 Kg/m
OUTDOOR	PVC-4CE	213652	1, 170 Kg/m

COPPER CONDUCTORS

Manufactured in electrolytic copper straps, conforming to the standard DIN 1787 / 17670 / 40500 and quality CU-ETP certification.

Density: 8,9 gr/cm³.

Expansion coefficient: 0,0165mm/m/°C.

Conductivity IACS: 100



MEDIDA	REFERENCIA	CÓDIGO	PESO
15x0,6mm	CU-40	213653	0,081 Kg/m
15x0,8mm	CU-60	213654	0,109 Kg/m
15x1,1mm	CU-80	213655	0,149 Kg/m
15x1,4mm	CU-100	213656	0,190 Kg/m

SLIDING HANGER

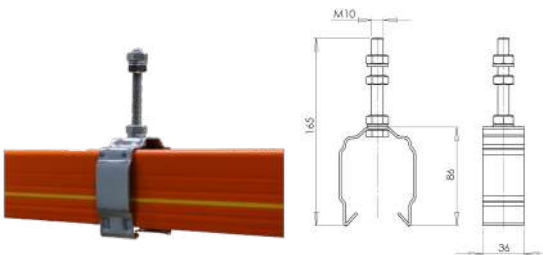

ENVIRONMENT	REFERENCE	CODE	MATERIALS	WEIGHT
INDOOR	SO-4	213215	Zinc plated steel	0,210 Kg
AGGRESSIVE ENVIRONMENT + OUTDOOR	SO-4E	213269	Zinc plated Steel coated EPOXY-POLYESTER paint Screws in stainless steel	0,220 Kg

Assembled every 2,000mts in indoor lines and every 1,333mts in outdoor lines, allowing longitudinal movements to the PVC profile.

JOINT

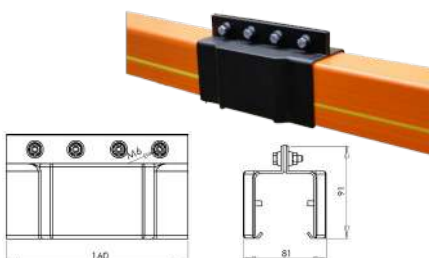

ENVIRONMENT	REFERENCE	CODE	MATERIALS	WEIGHT
INDOOR	EMPC-4	213657	Insulated material Screws in Zinc plated steel	0,212 Kg
AGGRESSIVE + OUTDOOR	EMPC-4E	213658	Insulated material Screws in Stainless steel.	0,212 Kg



MODULAR CONDUCTOR SYSTEM LC-4

FEEDING BOX

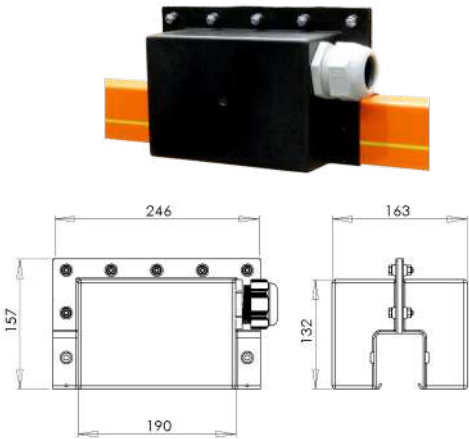

ENVIRONMENT	REFERENCE	CODE	CABLE ENTRY VIA 1 CABLE GLAND	CABLE Ø (FROM/ TO)	WEIGHT
INDOOR	AG-4-1xM25	213605	1 ud M25	Ø 13 / 18	1,050 Kg
	AG-4-1xM32	213606	1 ud M32	Ø 18 / 25	1,060 Kg
	AG-4-1xM40	213607	1 ud M40	Ø 22 / 32	1,100 Kg
	AG-4-1xM63	213608	1 ud M63	Ø 34 / 44	1,130 Kg
	AG-4-4xM25	213609	4 ud M25	Ø 13 / 18	1,120 Kg
	AG-4-4xM32	213610	4 ud M32	Ø 18 / 25	1,200 Kg
AGGRESSIVE + OUTDOOR	AG-4E-1xM25	213611	1 ud M25	Ø 13 / 18	1,050 Kg
	AG-4E-1xM32	213612	1 ud M32	Ø 18 / 25	1,060 Kg
	AG-4E-1xM40	213613	1 ud M40	Ø 22 / 32	1,100 Kg
	AG-4E-1xM63	213614	1 ud M63	Ø 34 / 44	1,130 Kg
	AG-4E-4xM25	213615	4 ud M25	Ø 13 / 18	1,120 Kg
	AG-4E-4xM32	213616	4 ud M32	Ø 18 / 25	1,200 Kg

CONNECTION SUPPORT FOR EXTREME FEEDING

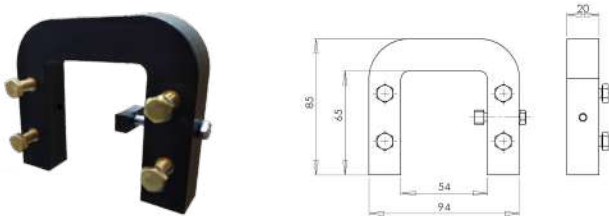

ENVIRONMENT	REFERENCE	CODE	WEIGHT
INDOOR	SC-4	213659	0,132 Kg

PVC CONNECTION PROFILE (2x500mm) FOR INTERMEDIATE FEEDING

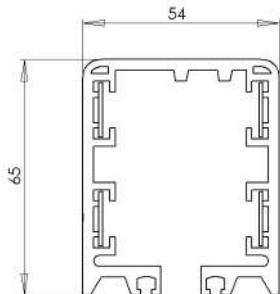

Standard length : 2 x 0,5 mts.



ENVIRONMENT	REFERENCE	CODE	WEIGHT
INDOOR	PAI-4C	213660	1,170 Kg
OUTDOOR	PAI-4CE	213661	1,170 Kg

END CAP

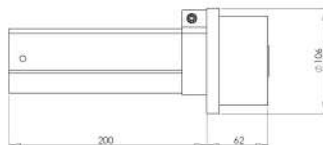

ENVIRONMENT	REFERENCE	CODE	MATERIAL	WEIGHT
INDOOR	TEC-4	213662	Isolating material Zinc plated steel screws	0,356 Kg
OUTDOOR	TEC-4E	213663	Isolating material Stainless steel screws	0,356 Kg

FIXED POINT CLAMP

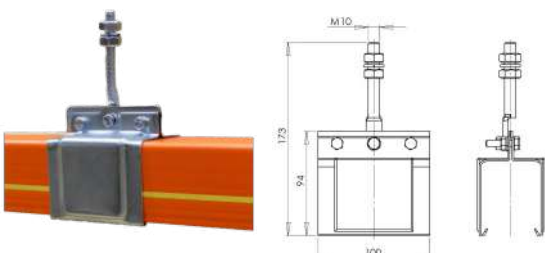

ENVIRONMENT	REFERENCE	CODE	MATERIALS	WEIGHT
INDOOR	PF-4	213209	Zinc plated steel	0,389 Kg
AGGRESSIVE + OUTDOOR	PF-4E	213285	Zinc plated steel coated with EPOXY-POLYESTER paint	0,399 Kg





MODULAR CONDUCTOR SYSTEM LC-4

CURRENT COLLECTOR

Ref. TO-4x35 A

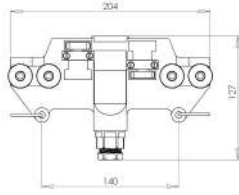

Each current collector includes:

- Insulated support.
- Ball bearings.
- Provided with 2m of extra-flexible 4G4 cable.
- Cable gland PG-16.
- Spring loaded carbon brushes 24 x 7 x 22mm. In N51 quality (Ref. ETO-4).
- Springs in stainless Steel AISI302.

Ref. TO-4x70 A

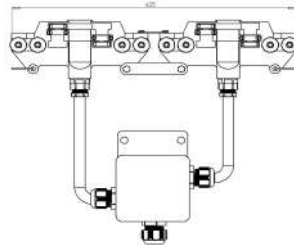

The use of double current collector is recommended in installations:

- with a consumption greater than 35Amp
- which use speed regulation by frequency control
- with low service voltage
- who want to ensure continuous contact between copper profile and brush.

Ref. TO-4x35 AC (for curved lines)

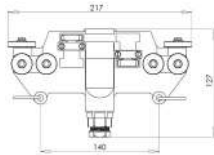

ENVIRONMENT	REFERENCE	CODE	DESCRIPTION	MAX. SPEED	WEIGHT
Indoor	TO-4x35 A	213211	Single trolley 35Amp	160m/min	1,120 Kg
	TO-4x70 A	213236	Double trolley 70Amp	90m/min	1,740 Kg
	TO-4x35 AC	213255	Trolley for curves 35Amp	130m/min	1,162 Kg
Outdoor	TO-4x35 A	213333	Single trolley 35Amp	160m/min	1,120 Kg
	TO-4x70 A	213336	Double trolley 70Amp	90m/min	1,740 Kg
	TO-4x35 AC	213334	Trolley for curves 35Amp	130m/min	1,162 Kg

TOWING ARM

Provides traction on the current collector trolley for its movement in the system. Steel coated with EPOXY-POLYESTER painted in dark gray RAL7021.

Ref. BA-4

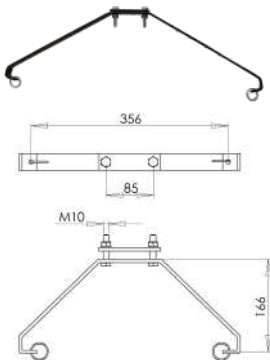

Ref. BA-4C

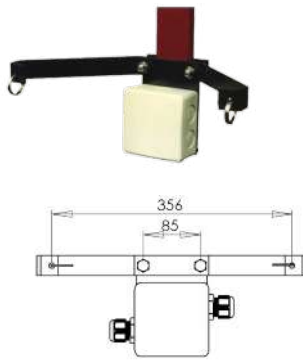

Ref. BA-70

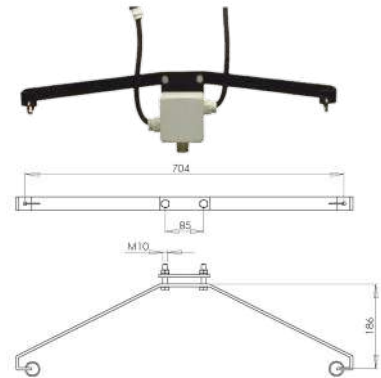

ENVIRONMENT	REFERENCIE	CODE	DESCRIPTION	WEIGHT
INDOOR	BA-4	213212	Single arm for trolley TO-4x35A y TO-4x35AC	0,813 Kg
	BA-4C	213319	Single arm with connection box for trolley TO-4x35A y TO-4x35AC	1,275 Kg
	BA-70	213270	Double arm for trolley TO-4x70A	1,600 Kg
OUTDOOR	BA-4E	213322	Single arm for trolley TO-4x35A y TO-4x35AC	0,813 Kg
	BA-4CE	213324	Single arm with connection box for trolley TO-4x35A y TO-4x35AC	1,275 Kg
	BA-70E	213323	Double arm for trolley TO-4x70A	1,600 Kg



MODULAR CONDUCTOR SYSTEM LC-4

AUXILIARY COMPONENTS

CONDUCTOR CLEANER

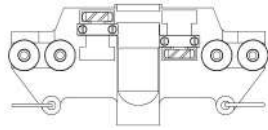

REFERENCE	CODE	MADE OF	WEIGHT
TO-4L	213527	Grooved carbon brushes	0,350 Kg

CARBON BRUSH

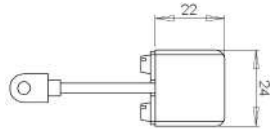

Metalgraphite N51 quality.
Provided with 2 springs in stainless steel AISI302.

REFERENCE	CODE	WEIGHT
ETO-4	213235	0,025 Kg

HOUSING VENTILATION

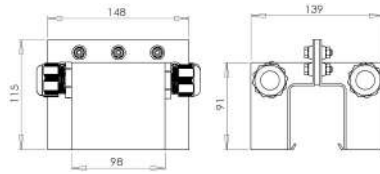

REFERENCE	CODE	WEIGHT
EV-4E	213350	0,400 Kg

To provide air ventilation in the assembly between two modular sections.
It is necessary to allow the exit of air from the interior of the system, preventing possible condensation. It is used in installations with different temperature changes, for example, systems with mixed zones of indoor and outdoor.

WOODEN DRAWING BLOCK

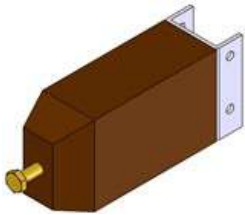

The wooden drawing block facilitates the insertion of the copper channels in each of the housings that has the PVC profile.

REFERENCE	CODE	WEIGHT
TAC-4	213665	1,000 Kg

COPPER PULLING CASSETTE



The copper channels to be inserted in the PVC profile are delivered in the form of a roll. Said winder allows the channels to be introduced little by little, as the drive block moves along the PVC profile.

REFERENCE	CODE	WEIGHT
DEV-4	213666	5,000 Kg

COPPER STRAIGHTENER



Used to straighten the copper channel before being inserted into the PVC housing

REFERENCE	CODE	WEIGHT
END-40	213667	0,600 Kg
END-60	213668	0,600 Kg
END-80	213669	0,600 Kg
END-100	213670	0,600 Kg



MODULAR CONDUCTOR SYSTEM LC-4

AUXILIARY COMPONENTS

UNIVERSAL SUPPORT

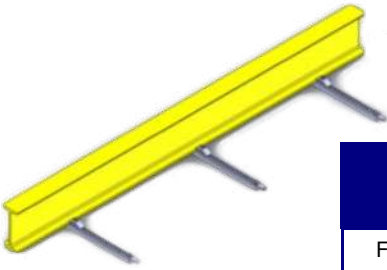

Prior to ordering, point out total length (L) of the cross support arm ref. 2331-1 or 2500-1.
Example: SU-500-1.

	REFERENCE	CODE	MATERIALS			WEIGHT
			Anchoring device	Beam clip	Track support	
For profile 2331-1	SU- -1	--	Zinc plated Steel	Zinc plated Steel	Zinc plated steel	-- kg
For profile 2331-1 Inox	SU- -1-Inox	--	Stainless Steel	Stainless steel	Stainless steel	-- kg
For profile 2500-1	SU- -2	--	Zinc plated Steel	Zinc plated Steel	Zinc plated steel	-- kg
For profile 2500-1 Inox	SU- -2-Inox	--	Stainless Steel	Stainless steel	Stainless steel	-- kg

SUPPORT ARM CLIP

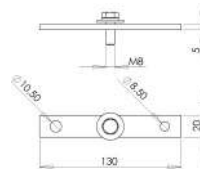

REFERENCE	CODE	MATERIALS		WEIGHT
		Body	Screws	
SU-4-1	713114	Zinc plated Steel	Zinc plated Steel	0,121 Kg
SU-4-1-Inox	713115	Stainless steel	Stainless steel	0,121 Kg
SU-4-2	713134	Zinc plated Steel	Zinc plated Steel	0,150 Kg
SU-4-2-Inox	713135	Stainless steel	Stainless steel	0,150 Kg

BEAM CLIP

45x20x5mm para perfil 2331-1
25x25x5mm para perfil 2500-1

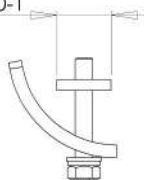

REFERENCE	CODE	MATERIALS		WEIGHT	
		Body	Screws		
For 2331-1 profile	2340-12	309005	Zinc plated steel	Zinc plated steel	0,140 Kg
For 2500-1 profile	2340-12-500	309006	Zinc plated steel	Zinc plated steel	0,156 Kg
For Inox 2331-1 profile	2340-12-Inox	309321	Stainless steel	Stainless steel	0,140 Kg
For Inox 2500-1 profile	2340-12-500-Inox	309316	Stainless steel	Stainless steel	0,156 Kg

WELD-ON BRACKET FOR SUPPORT ARM

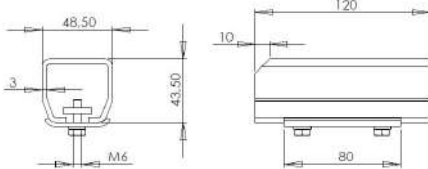

REFERENCE	CODE	MATERIAL	WEIGHT	
For 2331-1 profile	2331-100	302561	Steel	0,369 Kg
For 2500-1 profile	2600-120	310011	Steel	0,600 Kg

CLOSING PROFILE

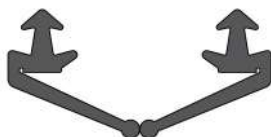

REFERENCE	CODE	WEIGHT
PC-4	213617	0,18 Kg/m

The closing profile PC-4 improves the tightness of the line, making it difficult to get dust inside the PVC casing. This accessory is assembled once the line has been assembled in its entirety by inserting it by hand into the lower part of the PVC profile.



MODULAR CONDUCTOR SYSTEM LC-4

ASSEMBLY INSTRUCTIONS

INDOOR SYSTEM WITH END FEED (Sliding hangers every 2 metres)

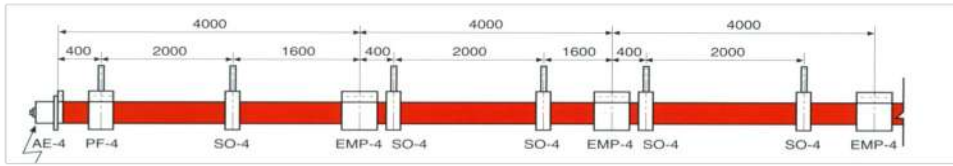

INDOOR SYSTEM WITH LINE FEED (Sliding hangers every 2 metres)

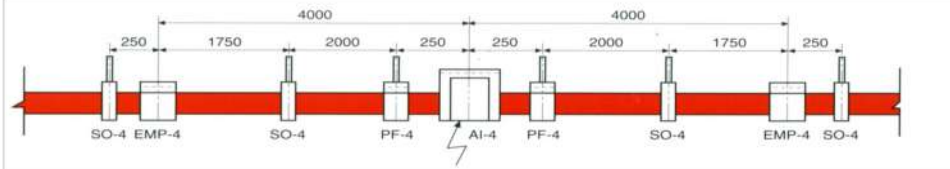

OUTDOOR SYSTEM WITH END FEED (Sliding hangers every 1,33 metres)

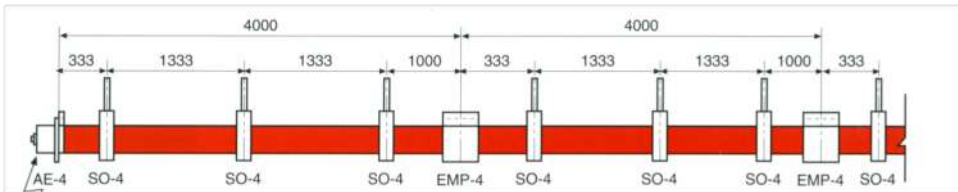

The fixed point clamp, PF-4 can also be installed in the middle of the system to disperse

1) SAFETY

Disconnect the electrical current from the system before beginning any assembly operation.
Do not use the Modular Line LM-4 for higher loads than the specified voltage and current.

2) INSTALLATION

The support structure for the power line must be capable of supporting the total weight of the system. Place the support points along the beam through which the hoist will move. These points should be located every 2m or every 1,333m depending on the type of line in question and according to previous sketch.



Install universal brackets every 2 or 1.33 meters, according to the assembly scheme



Assemble the sliding hangers SO-4 and the fixed points PF-4 on the support arms by tightening their corresponding screws.



Install the LC-4 line bars at the support points, respecting that the yellow "earth" signal line is always on the same side.



Fit and tighten the screws of the joint EMPC-4 splices. Check correct alignment between beam and power line.

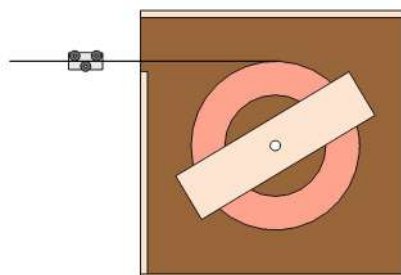

Insert the 4 copper channels on the PVC housing with the help of the copper pulling cassette and drawing block. Pass the copper channels over the straightener and tie the plate over the drawing block.

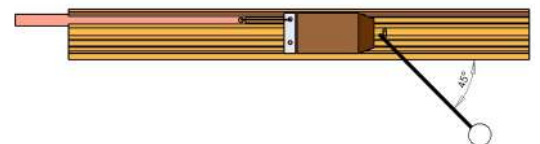

Slide the channel along the PVC housing with the help of the drawing block. The push must be done with a minimum angle of 45°.



ASSEMBLY INSTRUCTIONS



Insert the current collector, with manual pressure of brushes. Respect the unique position to avoid phase exchange.

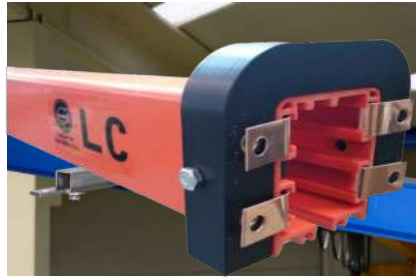

EXTREME FEED

Fix the connection support on the PVC profile and fold the 4 Cu 90° channels. Practice a hole of Ø 6mm at the ends of the channels.



EXTREME FEED

Fix terminals to each pole of the supply cable and connect them to their respective channels; Fixing them in the connection support. Assemble the feed box with its respective end cap. Assemble the fixed point in the vicinity of the feed box.

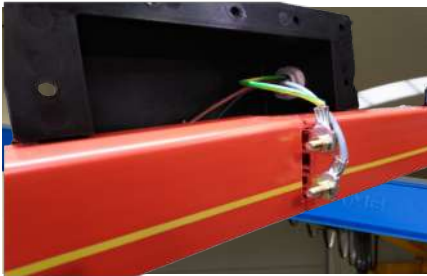

INTERMEDIATE FEED

Assemble the PC-4 connection channels between two standard sections of PVC at the connection point and connect them to the rest of the line. Remove the ends of the channels through the notches that have the PVC housing. Fold the 4 channels of Cu 90° and make a hole of Ø 6mm to each of them.



INTERMEDIATE FEED

Fix terminals to each pole of the supply cable and connect them to their respective channels. Assemble the feed box. Assemble a fixed point on each PC-4 connection profile



Assemble end caps to the rest of the line using their respective joints. The 200mm of length of cover, serves to absorb the dilatations and contractions of the line.



Assemble the BA-4 towing arm on the crane or hoist structure, aligning the chain pull with the central axis of the modular profile. The towings arm must be between 30mm and 50mm below that profile.

3) OPERATION

3.1 Previous tests

Carry out several travels by hand with the current collector to check that it moves throughout its length without problems. The extra-flexible cable of the current collector must be connected to the towing arm in a loop, without causing torsion of the trolley. Make the electrical connection to the line and test its insulation.

3.2 Final tests

Once the electric current is connected, check that the current collector moves forward and backward without problems. Check that the device that the LM-4 system is powered on works correctly.

3.3 Normal functioning

Do not exceed the maximum voltage and / or amperage specified for LM-4. Use the LM-4 line within its corresponding electrical and / or mechanical specifications.

4) MAINTENANCE

Perform periodic maintenance tasks to ensure the status of the LM-4 line. The maintenance operations will depend on the use given to the system. During each inspection the following points should be checked:

- Wear of ball bearings.
- Ensure screws are correctly tightened.
- Separation or alignment in the joints.
- Electric cables: cuts, cracks, etc...
- The profile must be clean in the running edges.



Industrias GALARZA, S.A.[®]

Leaders in electrical conductivity since 1958

RANGE OF PRODUCTS

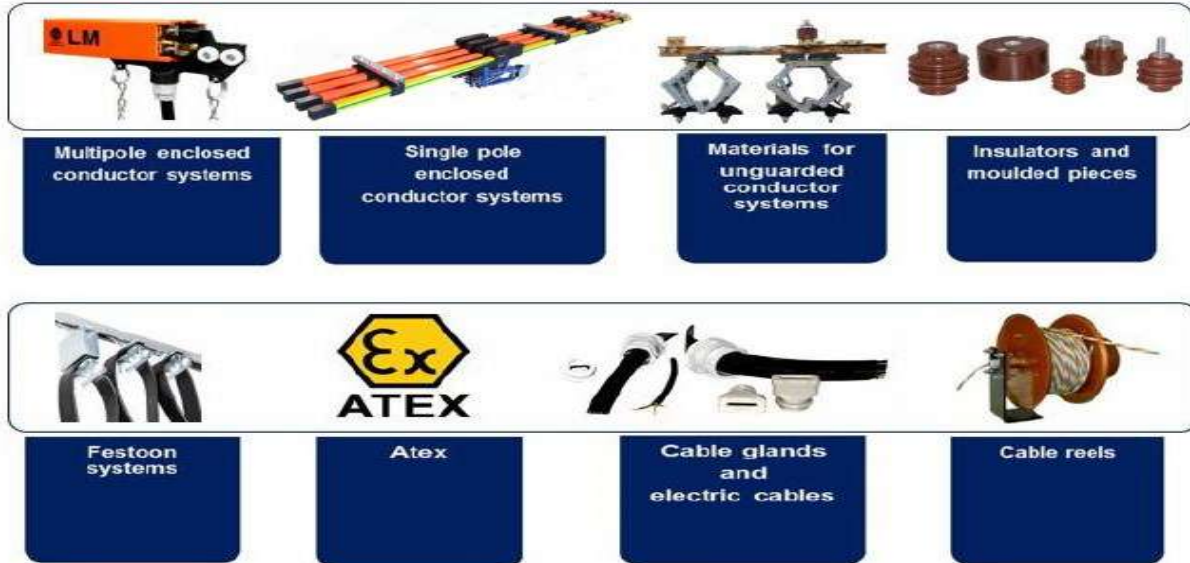

MARKETS

CRANES



PORTS&CONTAINERS HANDLING



BULK MATERIAL HANDLING



METALLURGY



MINING & ENERGY



TUNNELLING



ENVIRONMENTAL TECHNOLOGY



WIND POWER



AUTOMOTIVE



OFFSHORE



THEATRE STAGE TECH.



AGRICULTURE



INDUSTRIAS GALARZA S.A.
P.I. Bidosola, Pab. D-4
48142 ARTEA (BIZKAIA)
SPAIN

Tel. +34 944 47 18 12

Fax. +34 944 76 42 76

E.mail: info@industriasgalarza.com

www.industriasgalarza.com

DISTRIBUTED BY: